



BODY & PAINTSHOP, TIRESHOP



HEDSON TECHNOLOGIES

**One company - three brands,
Hedson Technologies offers you sustainable
solutions for all your needs in the workshop.**

With user experience in focus and based on innovative technology, all Hedson brands and products have one thing in common - to deliver technical solutions that meet the high demands of professional customers.

Hedson offers sustainable, durable and easy to use products for all areas and sizes of workshops.

ORIGINAL INNOVATORS, FOUNDED IN:

1967

- High quality curing
 - Infrared
 - UV-A LED
- Handheld
- Mobile
- Fixed installations
- Fast and precise
- Save energy
- Optimise workflow
- Save time



1974

- Pneumatic lifts
 - Lift on chassis
 - Lift on wheels
 - Duo function
- Durable
- Clean
- In ground
- On ground
- For prep area
- For spray booth



1978

- Spray gun cleaners
- Durable pumps
 - For water
 - For solvent
 - Combi systems
- Wheel Washers
 - Durable pumps
 - Smart user interface
- Integrated recycling



All Hedson original products are designed, developed and assembled in Sweden and Germany.

BODYSHOP SOLUTIONS



CURING EQUIPMENT

IRT IR and UV-A curing.

4



MIXING ROOM EQUIPMENT

Drester spray gun cleaners and other equipment for the mixing room.

36



LIFTING EQUIPMENT

Herkules lifts, dust extractions and lifting equipment.

49

TIRESHOP SOLUTIONS



TIRE SHOP EQUIPMENT

Drester wheel washers for the tireshop.

59



IRT CURING EQUIPMENT

Save space, time and money

A wide selection of high-quality, user-friendly, space saving short-wave infrared (IR) and ultraviolet (UV-A) IRT dryers.

A combination of 50+ years of curing know-how, high-end parts, sophisticated software and inhouse/third party/user tests will cure your material 100%, every time.

IRT mobiles and rail dryers provide reliable, high quality results with advanced curing technology that is easy to use. They are designed for the workshop, to save floor space and speed up the repair job process.

IRT provides maximum productivity in the body shop, always considering health and safety regulations.

- Controlled heat distribution
- Large curing areas
- Short curing times

IR CURING, DRY IN MINUTES

IRT IR dryers use gold coated reflectors for superior heat transfer management.

PAGE 4

UV-A CURING, DRY IN SECONDS

IRT UV-A dryers have an outstanding intensity, developed in cooperation with market leading paint manufacturers.

PAGE 12

IF YOU WANT IT ALL

The combination of IR and UV-A curing makes our IRT COMBI range unique.

PAGE 22

Gold coated reflectors	Infrared	Ultraviolet UV-A	Ultraviolet UV-A LED	Wear UV safety glasses	Powerful ventilation	Mobile dryer	Rail dryer	Distance control for preset programs	Non-contact temp. monitor	Battery operated	Cord operated	Handheld



IR HANDHELD & MOBILE DRYERS

Efficient, safe and quick IR drying

Handheld and IRT mobile dryers that cure all base coat and paint materials. Easy access with flexible arms that are easy to adjust.

HIGH-EFFICIENCY REFLECTORS

ADVANCED, USER FRIENDLY SOFTWARE

PAGE 6



UV-A HANDHELD & MOBILE DRYERS

High quality UV-A curing for all workshops

IRT UV-A curing with high intensity in a variety of models. Battery operated and handheld UV-A LED models and UV-A high efficiency pressure lamp mobiles.

OUTSTANDING INTENSITY

HIGH QUALITY DURABLE UV-A CURING

PAGE 12



RAIL DRYERS

Space savers with improved workflow

IRT Rail dryers are wall- and ceiling installations for prep stations and spray booths with IR- and/or UV-A availability from all angles.

NO LOOSE CABLES

MAINTENANCE FREE

PAGE 25



ARCH DRYERS

Improved throughput of vehicles in the workshop

In-booth and prep station curing that saves energy, time and space. IRT Arch dryers automatically move and identify the chosen car panel, using only the corresponding IR-lamps necessary.

CURES VEHICLES AND LOOSE PANELS

FULLY AUTOMATIC AND EASY TO USE

PAGE 28



IRT INFRARED CURING

Careful consideration of bodyshop heating requirements

To provide the best heat transfer possible, all IRT infrared (IR) dryers are equipped with unique gold coated reflectors.

IRT reflectors provide a superior heat distribution and a large curing area. Short-wave IR provides full heat immediately and penetrates deep into the paint. The paint cures from the inside and out without retaining solvents and moisture.

Heat loss to the air is minimal and all energy is transferred to the surface. IRT IR dryers irradiate the object and do not heat the surrounding air, thereby minimizing energy losses.

- Efficient use of energy
- Short drying times
- Large curing area
- High quality curing results

IRT CURING TIMES

Putty	5-6 min
Filler, bright/dark	7-15 min
Water based paint	4-6 min
Base coat	4-8 min
Top/clear coat, plastic filler	4-15 min
Plastic top/clear coat, soft cure	5-17 min
Final boost	2-4 min

The curing time is extremely short. Times above apply to the PcAuto range. Add a minute or two for other models.

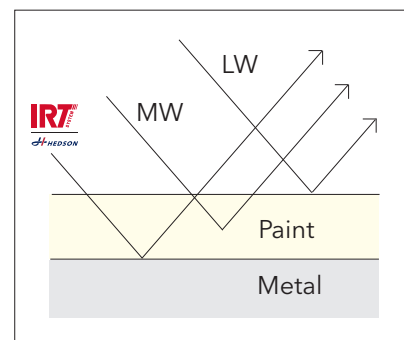

SIMPLIFIED DIAGRAM

Short-wave heat cures from the inside and out without retaining solvents and moisture.



ADVANCED AUTOMATIC DISTANCE AND TEMPERATURE CONTROL.

Look for these symbols for temperature measurement (pyrometer), laser circle and digital distance sensor. The surface temperature is continuously measured and the effective output regulated in a split second for optimal curing results.





IRT 1

Use handheld or attach to a stand (optional), for minor paint and panel work

- One lamp - output power 1 kW
- Gold coated reflector
- Best curing at 30 cm from the surface

DIMENSIONS

Handheld (LxHxD)	418x196x66 mm
Handheld weight	1,8 kg
Stand (HxW)	1450x350 mm
Stand weight	10 kg
Curing area*	0,17 m ²

* Curing area at a distance of 30 cm

IRT 1 PREPCURE, HANDHELD

Part no.	Current	Output power	Fuse	Voltage	Frequency
800429	4 A	1 kW	10 A	230V, 1 PH, EU	50-60 Hz
800624	4 A	1 kW	10 A	230V, 1 PH, UK (UK plug)	50-60 Hz
800431	4 A	1 kW	10 A	230V, 1 PH, AUS & ARG type 1	50-60 Hz
800432	9 A	1 kW	15 A	100V, 1 PH, JP	50-60 Hz
800428	9 A	1 kW	15 A	110V, 1 PH, NA (not ETL)	50-60 Hz
800524	9 A	1 kW	15 A	110V, 1 PH, NA ETL (fixed on stand - no timer)	50-60 Hz

STAND FOR IRT 1

Part no.	Voltage	
800460	230V, 1PH, EU	Stand with timer
800598	-	Stand without timer



IRT 2

Use handheld or attach to a stand (optional), for minor paint and panel work

- Two lamps - output power 2 kW
- Gold coated reflectors
- Best curing at 40-60 cm from the surface

DIMENSIONS

Handheld (LxHxD)	411x206x147 mm
Handheld weight	2,8 kg
Stand (HxW)	1450x350 mm
Stand weight	10 kg
Curing area*	0,44 m ²

* Curing area at a distance of 60 cm

IRT 2 PREPCURE, HANDHELD

Part no.	Current	Output power	Fuse	Voltage	Frequency
800433	9 A	2 kW	13 A	230V, 1 PH, EU	50-60 Hz
800625	9 A	2 kW	13 A	230V, 1 PH, UK (UK plug)	50-60 Hz
800472	9 A	2 kW	13 A	230V, 1 PH, AUS & ARG type 1	50-60 Hz
800434	9 A	2 kW	15 A	240V, 1 PH, NA ETL (fixed on stand - no timer)	50-60 Hz

STAND FOR IRT 2

Part no.	Voltage	
800460	230V, 1PH, EU	Stand with timer
800598	-	Stand without timer





IRT 3

Dryer adjustable in vertical position

- One cassette with 3 IR lamps
- Digital timers - flash off/full bake 30 + 30 minutes
- Settings will remain after power off

DIMENSIONS

Stand height	1531 mm
Cassette vertical range (height)	88-1300 mm
Width	694 mm
Weight	23 kg
Curing area*	1,0 x 1,1 m

* Curing area at a distance of 60 cm, on black sheet metal



IRT 3 PREPCURE

Part no.	Current	Output power	Fuse	Voltage	Frequency
800610	13 A	3 kW	16 A	230V, 1 PH, EU	50-60 Hz
800473	13 A	3 kW	13 A	230V, 1 PH, UK (UK plug)	50-60 Hz
800474	13 A	3 kW	16 A	230V, 1 PH, AUS & ARG type 1	50-60 Hz
800612	13 A	3 kW	20 A	230V, 1 PH, NA ETL	50-60 Hz

IRT 4

Dryer adjustable in both vertical and horizontal positions

- One cassette with 3 IR lamps, max height 2150 mm
- Digital timers - flash off/full bake 30 + 30 minutes
- Settings will remain after power off

DIMENSIONS

Stand height	1574 mm
Cassette vertical range (height)	160-2150 mm
Width	1188 mm
Weight	46 kg
Curing area*	1,0 x 1,1 m

* Curing area at a distance of 60 cm, on black sheet metal



IRT 4 PREPCURE

Part no.	Current	Output power	Fuse	Voltage	Frequency
800611	13 A	3 kW	16 A	230V, 1 PH, EU	50-60 Hz
800443	13 A	3 kW	13 A	230V, 1 PH, UK (UK plug)	50-60 Hz
800617	13 A	3 kW	16 A	230V, 1 PH, AUS & ARG type 1	50-60 Hz
800615	13 A	3 kW	20 A	230V, 1 PH, NA ETL	50-60 Hz



IRT 3-1

Standard dryer with process control

- One cassette with 3 IR lamps
- Computerized curing process, 12 preset and 3 custom programs
- Electronic distance sensor signals correct distance to curing surface

DIMENSIONS

Stand height	1435 mm
Cassette vertical range (height)	80-2550 mm
Width	1230 mm
Weight	53 kg
Curing area*	1,0 x 1,1 m

* Curing area at a distance of 60 cm, on black sheet metal

IRT 3-1 PCD

Part no.	Current	Output power	Fuse	Voltage	Part no.
800450	4 A	3 kW	10 A	400V, 3 PH, 4-pin, EU	50-60 Hz
800451	4 A	3 kW	10 A	400V, 3 PH, 5-pin, EU	50-60 Hz
800447	8 A	3 kW	10 A	230V, 3 PH, EU	50-60 Hz
800483	4 A	3 kW	10 A	400V, 3 PH, AUS	50-60 Hz
800467	13 A	3 kW	20 A	230V, 1 PH, NA ETL	50-60 Hz



IRT 3-2

Efficient curing for all types of paint materials

- Two cassettes - each with 3 IR lamps
- Computerized curing process, 12 preset and 3 custom programs
- Electronic distance sensor signals correct distance to curing surface

DIMENSIONS

Stand height	1435 mm
Cassette vertical range (height)	80-2550 mm
Width	1230 mm
Weight	62 kg
Curing area*	2,0 x 1,1 m

* Curing area at a distance of 60 cm, on black sheet metal

IRT 3-2 PCD

Part no.	Current	Output power	Fuse	Voltage	Frequency
800453	9 A	6 kW	16 A	400V, 3 PH, 4-pin, EU	50-60 Hz
800454	9 A	6 kW	16 A	400V, 3 PH, 5-pin, EU	50-60 Hz
800459	15 A	6 kW	16 A	230V, 3 PH, EU	50-60 Hz
800455	9 A	6 kW	16 A	400V, 3 PH, AUS	50-60 Hz
800484	15 A	6 kW	16 A	200V, 3 PH, 4P, JP	50-60 Hz
800458	26 A	6 kW	30 A	230V, 1 PH, NA ETL	50-60 Hz





ADVANCED AUTOMATIC DISTANCE AND TEMPERATURE CONTROL:

Pyrometer temperature measurement with laser circle indicator and digital distance sensor. The surface temperature is continuously measured and the effective output regulated in a split second for optimal curing results. Also allows for 3-step drying cycles.

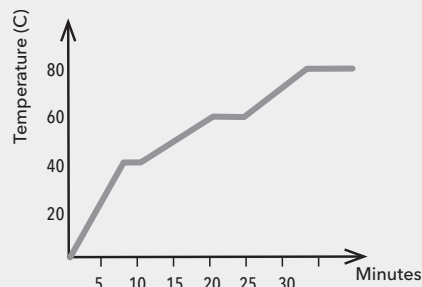

Example of a 3-step drying cycle, used for panel bonding and construction glues etc.



IRT 4-1 & 4-2 PCAUTO

High output dryer, easy to use with advanced curing technology, up to 110°C/230°F

- Automatic temperature control and distance measuring
- 15 process programs (3 customizable)
- Laser circle indicates where temperature measuring takes place
- Electronic distance sensor signals correct distance to curing surface

DIMENSIONS	IRT 4-1	IRT 4-2
Stand height	1450 mm	1450 mm
Cassette vertical range (height)	80-2500 mm	80-2500 mm
Width	1230 mm	1230 mm
Weight	53 kg	62 kg
Curing area*	1,1 x 1,5 m	2,2 x 1,5 m

*Curing area at a distance of 60 cm, on black sheet metal



IRT 4-1 PCAUTO

Part no.	Current	Output power	Fuse	Voltage	Frequency
800423	9 A	6 kW	10 A	400V, 3 PH, 4-pin, EU	50-60 Hz
800425	9 A	6 kW	10 A	400V, 3 PH, 5-pin, EU	50-60 Hz
800421	15 A	6 kW	16 A	230V, 3 PH, EU	50-60 Hz
800426	9 A	6 kW	10 A	400V, 3 PH, AUS	50-60 Hz
800485	15 A	6 kW	16 A	200V, 3 PH, 4P, JP	50-60 Hz
800422	26 A	6 kW	30 A	230V, 1 PH, NA ETL	50-60 Hz
800468	15 A	6 kW	16 A	230V, 3 PH, NA ETL	50-60 Hz
800427	9 A	6 kW	10 A	400V, 3 PH, AUS	50-60 Hz
800613	13 A	6 kW	20 A	440-480V, 2PH, 3P, NA ETL	50-60 Hz

IRT 4-2 PCAUTO

Part no.	Current	Output power	Fuse	Voltage	Frequency
800418	16 A	12 kW	16 A	400V, 3 PH, 4-pin, EU	50-60 Hz
800400	16 A	12 kW	16 A	400V, 3 PH, 5-pin, EU	50-60 Hz
800413	30 A	12 kW	32 A	230V, 3 PH, EU	50-60 Hz
800415	30 A	12 kW	32 A	200V, 3 PH, 4P, JP	50-60 Hz
800417	16 A	12 kW	16 A	400V, 3 PH, AUS	50-60 Hz
800411	48 A	12 kW	50 A	230V, 1 PH, NA ETL	50-60 Hz
800414	30 A	12 kW	30 A	230V, 3 PH, NA ETL	50-60 Hz
800419	16 A	12 kW	20 A	440-480V, 3 PH, NA ETL	50-60 Hz
800614	26 A	12 kW	30 A	440-480V, 2 PH, NA ETL	50-60 Hz

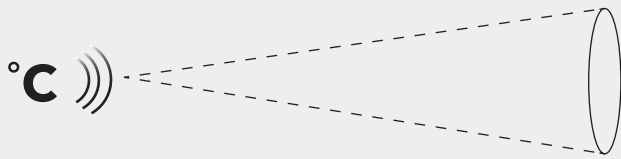

PCAUTO:

Place 60 cm from curing surface.
Laser circle sample area is Ø 30 cm (pyrometer ratio 1:2).
The pyrometer determines an average temperature reading in this area.

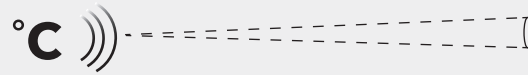

DTP:

Place 40-60 cm from curing surface.
Laser circle sample area is Ø 3-4 cm (pyrometer ratio 1:15).
The pyrometer determines an average temperature reading in this area.



IRT HIGH TEMPERATURE DRYERS

For spot repair and curing of paint material up to 200°C/390°F

- Automatic temperature control and distance measuring
- 15 process programs (customizable)
- Cures typical spot repair, A-B-C pillars and thicker steel materials



IRT 424 DTP 4-1



IRT 464 DTP 4-2

IRT HIGH TEMP DRYERS

Cassette	Drying surface (LxH)	No. of cassettes	No. of lamps	Power
IRT 4 HI-BAKE	300x300 mm	1	3	3 kW
IRT 424 DTP 4-1	400x300 mm	1	2	4 kW
IRT 424 DTP 4-2	1000x300 mm	2	4	8 kW
IRT 425 DTP 4-1	500x300 mm	1	2	4 kW
IRT 425 DTP 4-2	1200x300 mm	2	4	8 kW
IRT 428 DTP 4-1	800x300 mm	1	2	6 kW
IRT 428 DTP 4-2	1800x300 mm	2	4	12 kW
IRT 464 DTP 4-1 (6 kW)	600x600 mm	1	6	6 kW
IRT 464 DTP 4-1 (10 kW)	600x600 mm	1	6	10 kW
IRT 464 DTP 4-2 (12 kW)	1200x600 mm	2	12	12 kW
IRT 464 DTP 4-2 (20 kW)	1200x600 mm	2	12	20 kW

Please contact your local retailer or IRT sales contact for assistance with a suitable IRT DTP dryer.



IRT 4 HI-BAKE

HiBake is a *MANUAL* alternative to the DTP model, with 50% flash-off, 100% fullbake.



ULTRAVIOLET (UV-A) CURING

UV-A dryers with outstanding curing performance

All IRT UV-A models have an outstanding intensity to achieve the best curing result, even curing thick filler layers.

IRT UV-A high efficiency pressure lamp mobiles are equipped with one or two 1000 W UV-A lamps which cure UV-A material in just a few minutes. The ozone-free lamps and protective glass filters out the UV-B and UV-C radiation. A safety switch prevents the lamps from igniting if the glass breaks. Our UV-A LED models are extremely efficient, curing UV-A primer and filler in seconds.

- Outstanding intensity
- High-quality and durable curing
- Developed with market leading paint manufacturers

HANDHELD MODELS, UV-A LED

Battery- and cord operated models available in 365 nm and 395 nm. High-intensity, flexible and precise UV-A LED curing for specific wavelengths.

MOBILE MODELS, UV-A PRESSURE LAMPS

Mobile, long-life, low maintenance, high efficiency UV-A curing with large curing area.

SAFE UV-A CURING

Third party UV safety report (EN62471) for operator safety. UV-LED modules and low pressure bulbs are installed safely behind protective glass. Ozone-free low pressure bulb lamp design.

SAFETY FIRST

Always use UV safety glasses when handling UV-A light. We supply a pair with each delivered unit.

IRT
SYSTEM

IRT UVA 1-3

Curing with high efficiency UV-A lamps

- Curing on vertical surfaces
- One UV-A lamp with protective glass
- Curing time is regulated with an electronic timer

IRT UVA 1 PREPCURE 3

Part no.	Power	Fuse	Voltage	Frequency
800604	1 kW UV-A	10 A	230V, 1 PH, EU	50-60 Hz
800668	1 kW UV-A	10 A	230V, 1 PH, AUS & ARG type 1	50-60 Hz
800671	1 kW UV-A	15 A	230V, 1 PH, NA	50-60 Hz

DIMENSIONS

Stand height	1531 mm
Cassette vertical range (height)	60-1310 mm
Width	694 mm
Weight	60 kg
Curing area*	1,0 x 1,0 m

* At a distance of 55 cm



IRT UVA 1-4

High-quality, durable UV-A curing

- Flexible stand enabling curing of roofs on vehicles
- One UV-A lamp with protective glass
- Curing time is regulated with an electronic timer

DIMENSIONS

Stand height	1448 mm
Cassette vertical range (height)	35-2200 mm
Width	1224 mm
Weight	65 kg
Curing area*	1,0 x 1,0 m

* At a distance of 55 cm



IRT UVA 1 PREPCURE 4

Part no.	Power	Fuse	Voltage	Frequency
800621	1 kW UV-A	10 A	230V, 1 PH, EU	50-60 Hz
800669	1 kW UV-A	10 A	230V, 1 PH, AUS & ARG type 1	50-60 Hz
800672	1 kW UV-A	15 A	230V, 1 PH, NA	50-60 Hz

IRT UVA 2-4

Large curing area with two UV-A lamps

- Flexible stand enabling curing of roofs on vehicles
- Two UV-A lamps with protective glass
- Curing time is regulated with an electronic timer

IRT UVA 2 PREPCURE 4

Part no.	Power	Fuse	Voltage	Frequency
800622	2 kW UV-A	10 A	230V, 1 PH, EU	50-60 Hz

DIMENSIONS

Stand height	1448 mm
Cassette vertical range (height)	35-2200 mm
Width	1224 mm
Weight	81 kg
Curing area*	1,8 x 1,0 m

* At a distance of 55 cm





IRT UV-A LED CURING

WHY UV-A LED CURING?

UV-A curing with Light-Emitting Diodes (LED) generates, near-instant curing intensity, cold curing the painted surface without heating up the surrounding air.

Overall maintenance is reduced and the elimination of a warm-up cycle reduces technician down time.

WHAT IS A PHOTO INITIATOR (PI)*?

The energy in the UV-A light polymerizes and cures the UV-A material. The chemical reaction is triggered by a photo initiator and the speed of the process is determined by the energy or intensity of the UV-A light source and the wavelength.

WHY THIRD PARTY INSPECTION?

Third party testing confirms that a product exceeds quality, safety, sustainability and performance of applicable standards for a global product.

Two independent 3rd party inspectors (RISE and Intertek) review our products and our user instructions.

BENIFITS OF INDUSTRY COOPERATION?

By working closely with major paint manufacturers, crucial user experience and expectancy are added to our product development.

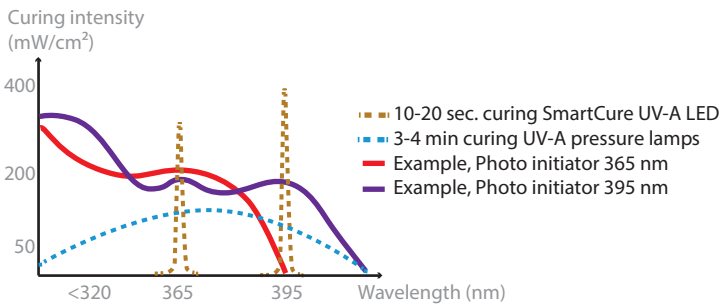

*Illustrating the correlation between PI wavelength, curing speed and UV-A light intensity.



SmartCure is available in wavelength alternatives 365/395 nm, based on paint manufacturer requests. It is prepared for future adaptations and can be retrofitted from 395 nm to 365 nm.

100% CURED

Non-fluctuating curing cycle

The key to high quality, reliable results is in maintaining a non-fluctuating intensity through the complete curing cycle.

Therefore, measuring and comparing light intensity is tricky, showing only a moment of truth. Once the primer/filler surface is sealed, you need to rely on the inside being cured.

With IRT, a combination of curing know-how, high-end parts, sophisticated software and inhouse/third party/user tests will cure your material 100%, every time.

Know-how

50+ years of experience and long-term cooperation with paint manufacturers.

= Reliable results.

Testing

3rd party EC and North American ETL approval. Lightweight design in cooperation with 3rd party industrial designers.

= Operational and ergonomic safety.

Software*

Easy access display with curing time and battery indicator. Advanced monitoring of all electronic parts. No overheating or fluctuation.

= Operational genius.

Hardware*

Top of the line, made in Europe, batteries, charger and UV-LED module. Sophisticated cooling system.

= No operator downtime.

**100%
CURED**

*Example, SmartCure

IRT TESTING

We have tested UV-A fillers, primers and clear coats from every major paint manufacturer and offer solutions for all.

Flexible handheld/fixed cord solutions for the static work place. Battery operated lightweight handheld options for accessibility that eliminates downtime in the work shop.

Our UV-A LED options are available for 365 nm and 395 nm.

IRT UV-A

We have long experience in a leading position on the international curing and drying market.

Our UV-A range of products for body shops and manufacturing industries comes in all shapes, super light handheld tools and easy positioned heavy duty mobiles.

Also checkout IRT's range of UV-A pressure lamps combined with IRT infrared technique, available as mobiles and rail systems for a wider UV-A spectrum.



IRT UV SMARTCURE

200 W UV-A LED battery operated curing

SmartCure comes with two exchangeable batteries and cures UV-A filler and primer in seconds, available for 365 nm/ 395 nm.

IRT UV SmartCure has an extremely powerful output, offering market leading peak/average light intensity.

By combining a powerful UV-LED-module, advanced cooling technology and light weight batteries, reliable, highly effective, non-fluctuating UV-curing is achieved.

Advanced electronics minimizes the risk of machine damage by active ventilation and by monitoring the temperature of both electronics and LED-module. This provides safe operation with efficient steady state voltage LED-output and current control regulation.

- Available for 365 nm/ 395 nm
- Weighs just 1 kg, for excellent work comfort
- High intensity is constant until battery is at 0%



ELIMINATE DOWNTIME

With two exchangeable 18V lithium-ion batteries and 45 minute charging time, IRT UV SmartCure is always available.

RELIABLE CURING RESULTS

By working closely with leading paint manufacturers IRT enables reliable paint processes in all bodyshops.

ULTIMATE CURING GUIDE

To obtain peak performance, work at appr 100 mm from surface.
 @ filler/primer thickness 80-120 μm ,
 Ø 160 mm is cured in appr 10 sec.
 (Peak light intensity $>350 \text{ mW/cm}^2$,
 average $>250 \text{ mW/m}^2$).



WALL BRACKET
Magnetic wall bracket, included as standard.



DUST COVER
Optional protective dust cover with magnets, art no 715193.



UNIQUE BEAM SPREAD
24 pieces of domed LED's create a unique beam spread over the complete curing area.



HARD CASE*
Optional heavy-duty case, art no 800806.



CARDBOARD BOX*

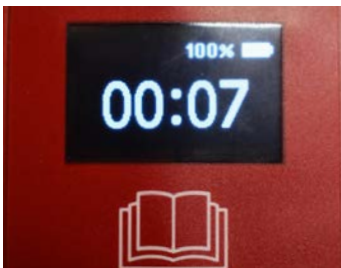

DISPLAY GUIDES THE WAY
All fillers, primers and clear coats have different curing cycles.



LOW MAINTENANCE
Replaceable filter protects electronics inside, art nr 715074.

SUPER LIGHT AND ERGONOMIC
Tested to withstand high impact. Flame resistant plastic shell reinforced with 25% glass fiber and 3 mm scratch and solvent resistant tempered safety glass. Light-weight comfort and easy to use with a precise trigger switch.



DETAILS

Battery type	18 V Lithium-ion
Weight, IRT UV SmartCure + 1 battery	1,16 kg
Dimensions, IRT UV SmartCure + 1 battery (WxHxD)	189x250x88 mm

IRT UV SMARTCURE

Part no.	Article	Current, SmartCure / Charger	Power	Voltage (Battery charger)	Risk Group EN 62471	Frequency
715070-X*	SmartCure 395 nm	8A/2A	200 W	100-240 V	(RG-3)	50-60 Hz
715365-X*	SmartCure 365 nm	8A/2A	200 W	100-240 V	(RG-3)	50-60 Hz

2 batteries, charger, magnetic wall bracket and UV Safety glasses included in delivery. Ambient temp max 40° C.

* SmartCure 395 nm alternatives:
EU; in cardboard box 715070-1 / EU; in hard case 715070-2
NA; in cardboard box 715070-3 / NA; in hard case 715070-4
UK; in cardboard box 715070-5 / UK; in hard case 715070-6
JP; in cardboard box 715070-7 / JP; in hard case 715070-8
AUS; in cardboard box 715070-9 / AUS; in hard case 715070-10

* SmartCure 365 nm alternatives:
EU; in cardboard box 715365-1 / EU; in hard case 715365-2
NA; in cardboard box 715365-3 / NA; in hard case 715365-4
UK; in cardboard box 715365-5 / UK; in hard case 715365-6
JP; in cardboard box 715365-7 / JP; in hard case 715365-8
AUS; in cardboard box 715365-9 / AUS; in hard case 715365-10



NEXT GENERATION UV LAMPS FROM IRT

IRT UV SPOTCURE²

3 times stronger on spot and panel repairs

POWERFUL DETAIL

- 132 high-power LED
- Individual optics on each LED
- Temperature regulated ventilation
- Reliable curing results, built to last

POWER-UP

- More light intensity over a larger surface
- Cures Ø 30 cm (12") in 20 seconds
- Cures Ø 70 cm (27.5") in a minute
- Cures Ø 100 cm (39.4") in 2 minutes

BETTER FOR YOU

- Multifunction timer display
- Press and go, saves your last settings
- Ergonomic grip
- Light-weight stand (optional)



3 TIMES MORE POWERFUL*

Our bestselling UVLED range expands with power-packed SpotCure².

An unbeatable combination of power and curing size.

Taking operational safety and user comfort to a new level.

*SpotCure¹ light effect 50 W, SpotCure² light effect 150 W.

NEXT GENERATION UV LAMPS FROM IRT

IRT UV SPOTCURE²

More light intensity over a larger area



POWERPACKED SPOTCURE²

Curing areas like never before, with the same reliable curing result. Perfectly balanced hand comfort for spot repair or panel repairs (with optional stand).

Powerful, temperature regulated ventilation - built to last

Uniform light intensity

Advanced overheating protection

User comfort with grip ribs and membrane display

DIY exchangeable power cord

Filter replacement indicator

User preference memory function

Operational safety with third party certification

Multi-function timer display guides the way

Ergonomic design - for a healthier work environment



NEXT GENERATION UV LAMPS FROM IRT

IRT UV SPOTCURE²

Hand- and stand operation



Comfortable with ergonomic design and grip ribs.
Press and go, saves your last settings.

TECHNICAL DATA IRT UV SPOTCURE ²	
Voltage	100- 240 V
Power	300-400 W
LED unit	132 pcs high power, individual optics
Weight, SpotCure ²	2 kg (4 lbs)
Weight, Stand for SpotCure ²	11.5 kg (25 lbs)
Dimensions, SpotCure ²	335 x 116 x 172 mm (13" x 4.5" x 7")
Dimensions, Stand for SpotCure ²	622 x 605 x 1940 mm (24.5" x 24" x 76")
LED Wavelength	395 nm UV-A
Risk Group EN 62473	3
PART NO.:	
IRT UV SpotCure ²	EU: 800900 / UK: 800901 / NA: 800902
Stand for IRT UV SpotCure ²	800907
Hard case for SpotCure ²	800906
5 pcs inlet filter+5 pcs outlet filter	715425
Power cord, 1.8 m	EU: 715429 / UK: 715430 / NA: 715431
UV safety glasses	129070*

*1 pair included in delivery

NEXT GENERATION UV LAMPS FROM IRT

IRT UV SPOTCURE²

CURING FACTS SPOTCURE²

132 high power LEDs, each with unique optics. Designed to create high and uniform LED light intensity over a large area.

Combined with powerful, temperature regulated ventilation and advanced overheating protection, SpotCure² offers market leading curing results from IRT, the curing company.

Product lifetime, operational safety and ergonomics are always top priority.

10 CM (4") DISTANCE	
Curing area	Ø 30 cm (12")
Light intensity average/peak	90/120 mW/cm ²
Curing time	10-20 sec*
30 CM (12") DISTANCE	
Curing area	Ø 70 cm (27.5")
Light intensity average/peak	14/19 mW/cm ²
Curing time	1 minute*
40 CM (18") DISTANCE	
Curing area	>Ø 100 cm (39.5")
Light intensity average/peak	<8 mW/cm ²
Curing time	<2 minutes*

*Average curing times for a selection of UV Fillers available on the market. Details for specific UV activated materials are individual and can vary.



132 high power LEDs, each with unique optics.

Closer to object >> Smaller curing area >> Higher intensity >> Shorter curing time
 Further from object >> Larger curing area >> Lower intensity >> Longer curing time



COMBINATION OF IR AND UV-A CURING

Our best in class IR and UV-A dryers in one

The IRT COMBI dryer is 2 in 1 - saving space in the workshop while allowing complete flexibility.

The combination of short-wave infrared and UV-A radiation makes this mobile dryer unique. One cassette includes 4 IR lamps and 1 UV-A lamp.

The UV-A lamps have an outstanding intensity to achieve the best curing result. The infrared lamps are mounted in gold coated reflectors, reflecting up to 97 % of the short-wave radiation.

The IRT COMBI features 12 IR and 3 UV-A pre-programmed programs for water and solvent based paint material, from putty to clear coat. Available as flexible mobiles and easy-gliding rail dryers.

- High-quality and durable curing
- Space saving curing solution
- Short-wave IR drying and UV-A curing

SAFE UV-A CURING

The ozone-free lamps and the protective glass filters out the UV-B and UV-C rays. If the glass breaks or is missing, the light has a safety switch preventing the lamp to ignite.

FLEXIBILITY AND EFFICIENCY

Space saving infrared and UV-A drying techniques which can be run individually and in sequence.

SAFETY FIRST

Always use UV safety glasses when handling UV-A light. We supply a pair with each delivered unit.



IRT 4-1 IR-UVA

Mobile dryer with unique combination of IR and UV-A techniques

- One cassette with 4 IR lamps and 1 UV-A lamp
- Featured with 12 IR- and 3 UV-A pre-programmed programs
- Easy to position

DIMENSIONS

Stand height	1450 mm
Cassette vertical range (height)	80-2240 mm
Width	1230 mm
Weight	70 kg
Curing area	
- IR*	1,1 x 1,5 m
- UV-A**	1,0 x 1,0 m

* Curing area at a distance of 60 cm, on black sheet metal
** At a distance of 55 cm

IRT COMBI 4-1 IR-UVA

Part no.	Power	Fuse	Current	Voltage	Frequency
800605	IR: 6 kW UVA: 1,2 kW	10 A	IR: 9 A UVA: 3 A	380-420V, 3 Ph/PE	50-60 Hz



IRT 4-2 IR-UVA

Mobile dryer with unique combination of IR and UV-A techniques

- Two cassettes, each cassette equipped with 4 IR lamps and 1 UV-A lamp
- Featured with 12 IR- and 3 UV-A pre-programmed programs
- Easy to position

DIMENSIONS

Stand height	1450 mm
Cassette vertical range (height)	80-2240 mm
Width	1230 mm
Weight	85 kg
Curing area	
- IR*	2,2 x 1,5 m
- UV-A**	1,8 x 1,0 m

* Curing area at a distance of 60 cm, on black sheet metal
** At a distance of 55 cm

IRT COMBI 4-2 IR-UVA

Part no.	Power	Fuse	Current	Voltage	Frequency
800606	IR: 12 kW UVA: 2,4 kW	16 A	IR: 16 A UVA: 6 A	380-420V, 3 Ph/PE	50-60 Hz





IRT 4-10 IR-UVA

Rail dryer with IR and UV-A radiation

- One cassette with 4 IR lamps and 1 UV-A lamp
- 12 IR- and 3 UV-A pre-programmed programs
- Unique combination of IR and UV-A curing



IRT COMBI 4-10 IR-UVA

Part no.	Power	Fuse	Current	Voltage	Frequency
800618	IR: 6 kW UVA: 1,2 kW	Max 100 A	IR: 9 A UVA: 3 A	380-420V, 3 Ph/PE	50-60 Hz

DIMENSIONS

Installation height	2250-3150 mm
Cassette vertical range (height)	80-2240 mm
Weight	70 kg
Curing area	
- IR*	1,1 x 1,5 m
- UV-A**	1,0 x 1,0 m

* Curing area at a distance of 60 cm, on black sheet metal
** At a distance of 55 cm

IRT 4-20 IR-UVA

Rail dryer with IR and UV-A radiation

- Two cassettes, each cassette equipped with 4 IR lamps and 1 UV-A lamp
- 12 IR- and 3 UV-A pre-programmed programs
- Unique combination of IR and UV-A curing



IRT COMBI 4-20 IR-UVA

Part no.	Power	Fuse	Current	Voltage	Frequency
800619	IR: 12 kW UVA: 2,4 kW	Max 100 A	IR: 16 A UVA: 6 A	380-420V, 3 Ph/PE	50-60 Hz

DIMENSIONS

Installation height	2250-3150 mm
Cassette vertical range (height)	80-2240 mm
Weight	85 kg
Curing area	
- IR*	2,2 x 1,5 m
- UV-A**	1,8 x 1,0 m

* Curing area at a distance of 60 cm, on black sheet metal
** At a distance of 55 cm



WORKSHOP CUSTOMIZATION

Please contact your local retailer or IRT sales contact for assistance with customization for your workshop.

IRT RAIL SYSTEMS

Tailor-made for prep area and spray booth

Operational safety with integrated cables

The IRT Rail System can be equipped with any number of IRT dryers, all hanging on easy-glide, self-balanced cassette arms.

With the IRT Rail System you can quickly maneuver the dryer into the perfect curing position, reaching all parts of the vehicle, without obstructing loose cables. The IRT Rail System comes in a variety of shapes and sizes and is customizable to suit any type of workshop.

OPERATIONAL SAFETY

High quality with closed rails and integrated cable system extends lifetime and creates a maintenance free environment.

LOWBUILT TO SUIT WORKSHOPS

Long experience with rail system installation has resulted in this extremely lowbuilt construction.

FOR PREP AREA & SPRAY BOOTH

Our standard sidehung cross rail system fits most workshops. Customized solutions are also available to fit all prep areas and paint booths.



SIDEHUNG CROSS RAIL SYSTEM Standard.
(Max length cross rail 7 m (22'11"))

UNDERHUNG CROSS RAIL SYSTEM



WALL RAIL SYSTEM



RAIL SYSTEM





IRT RAIL DRYERS

Easy gliding and self-balancing dryers



SAFE AND CLEAN

As the electric power supply is integrated in the rails, there are no loose cables dragging along the floor disrupting work and stirring up dust.



IRT CONTROL SYSTEM

User-friendly advanced system, pre-programmed to monitor the curing process.



DUST & SURVEILLANCE SYSTEM

Optional, use in enclosed spray booth or combined spray and dry booth. Security control of unit and protection of the cassettes.



IRT 3-20

Adapted for prep station and spray booth

- Two cassettes - each cassette with 3 IR lamps
- Electronic distance sensor
- Computerized curing process



IRT 3-20 PCD

Part no.	Current	Output power	Fuse	Voltage	Frequency
800477	15 A	6 kW	16 A	200-230V, 3 PH, EU, JP	50-60 Hz
800463	9 A	6 kW	16 A	400V, 3 PH, EU	50-60 Hz

DIMENSIONS

Installation height	2250-3150 mm
Cassette vertical range (height)	140-2500 mm
Weight	60 kg
Curing area*	2,0 x 1,1 m

* Curing area at a distance of 60 cm, on black sheet metal



IRT 4-10

User friendly advanced technology

- One cassette with 4 IR lamps
- Controls the temperature with a pyrometer and laser circle
- Computerized monitoring of curing
- Electronic distance sensor



IRT 4-10 PCAUTO

Part no.	Current	Output power	Fuse	Voltage	Frequency
800489	9 A	6 kW	10 A	400V, 3 PH, EU	50-60 Hz
800525	15 A	6 kW	20 A	200-230V, 3 PH, NA ETL	50-60 Hz
800494	9 A	6 kW	15 A	440-480V, 3 PH, NA ETL	50-60 Hz

DIMENSIONS

Installation height	2250-3150 mm
Cassette vertical range (height)	140-2500 mm
Weight	50 kg
Curing area*	1,1 x 1,5 m

*)Curing area at a distance of 60 cm, on black sheet metal

IRT 4-20

User friendly advanced technology

- Two cassettes with 4 IR lamps
- Controls the temperature with a pyrometer and laser circle
- Computerized monitoring of curing
- Electronic distance sensor



IRT 4-20 PCAUTO

Part no.	Current	Output power	Fuse	Voltage	Frequency
800480	30 A	12 kW	32 A	200-230V, 3 PH, EU, JP	50-60 Hz
800498	30 A	12 kW	30 A	200-230V, 3 PH, NA ETL	50-60 Hz
800464	17 A	12 kW	20 A	400V, 3 PH, EU	50-60 Hz
800479	17 A	12 kW	20 A	440-480V, 3 PH, NA ETL	50-60 Hz

DIMENSIONS

Installation height	2250-3150 mm
Cassette vertical range (height)	140-2500 mm
Weight	60 kg
Curing area*	2,2 x 1,5 m

*)Curing area at a distance of 60 cm, on black sheet metal

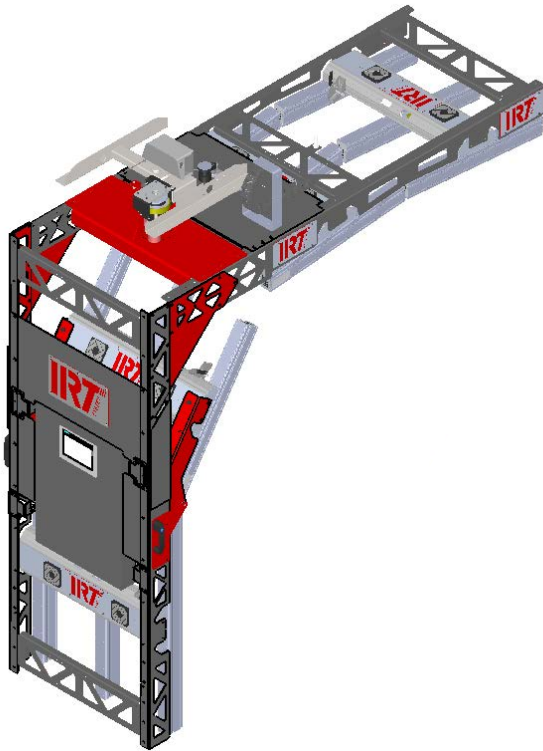

IRT FLEXICURE

Shorter curing times in the prep area

IRT FlexiCure moves over the chosen panel automatically, curing from the inside out, preventing solvent to be trapped inside the coating, ensuring fast and high quality curing.

Accelerated curing in the prep area, both automatic and manual, static and dynamic. Simply choose the desired panels to be dried and start the curing process thereby contributing to a cost-effective and environmental friendly process.

- Flexible installation in prep area with IRT Rails
- Tiltable zone for adjusted effect
- Requires very little parking space

TIME SAVING IN THE PREP AREA

IRT FlexiCure is installed in a standard IRT Rail System and accelerates curing of water- and solventbased base and clear coats.

4 CURING ZONES

Each zone is equipped with shortwave infrared lamps, gold coated reflectors and pyrometer. 3 IR lamps/zone with a total power of 38 kW.

COST EFFECTIVE PROCESS

IRT FlexiCure saves energy by only activating the necessary IR lamps using pyrometers and distance sensors.

WORKSHOP CUSTOMIZATION

Please contact your local retailer or IRT sales contact for assistance with customization for your workshop.

TECHNICAL DATA

Rated voltage	Nominal frequency	Full load current	Main disconnect fuse	Sound pressure level	Sound power level	Curing temp. (curing surface)	Ambient temp. (during operation)	Weight FlexiCure excluding rails
400-480 V ~3Ph/PE ± 5%	50-60 Hz	55 A	65 A	≤ 70 dB (A) at 1 m	≤ 70 dB (A) at 1 m	Max. 170°C	Max. 40°C	150 kg



IRT POWERCURE

Shorter curing times in the spray booth

IRT PowerCure drastically shortens curing times for all paint materials with a minimum of energy used.

IRT PowerCure turns your traditional booth into a rapid curing booth. The vehicle is ready to move forward in minutes. Selection of panels and paint type is done quickly and easily on the touch control panel. The vehicle and loose parts can be cured in the same drying cycle.

IRT PowerCure can be installed in new spray booths as well as be retrofitted in existing spray booths. Calculate 1,2 m for IRT PowerCure and another minimum 8 meters to pass over the vehicle and angle front/back.

- Easy to retrofit in spray booth (min 9,2 m)
- Reaches front/back of vehicle with angling wings
- Adapts to paint material, size and shape of vehicle
- A typical coating is cured in 10 minutes or less

WORKSHOP CUSTOMIZATION

Please contact your local retailer or IRT sales contact for assistance with customization for your workshop.

TECHNICAL DATA

Frequency	Installed Power	Voltage	Part no.
50-60 Hz	54 kW / 63 A (20 lamps à 3 kW less 6 kW supply voltage compensation)	400 V, 3Ph ~/PE	800410* IRT PowerCure Single 800490* IRT PowerCure Double

*) Incl. Surveillance System

EVEN HEAT DISTRIBUTION

The front and back of the vehicle are easily cured with the wing angled towards the painted surface. The shape and positioning of the reflectors give an even heat distribution.

LESS ENERGY CONSUMPTION

IRT PowerCure detects the starting position and saves energy by only activating the necessary IR lamps. Simply choose the desired panels to be dried and start the curing process.

ENERGY CONSUMPTION

Typical energy consumption, clear coat on base coat, medium sized vehicle, medium colour shade:

Front wing	6 min	0,95 kWh
Door	5 min	0,95 kWh
Front wing + door	10 min	1,6 kWh
Hood	7 min	1,5 kWh
Hood + 2 wings	9 min	2,8 kWh
Complete car	26 min	15,8 kWh



ENERGY SAVING, ROBOTIC CURING FROM IRT

IRT ICURE

Robotic, all inclusive dryer for booth and prep zone

COMPACT ROBOTIC RAIL DRYER

- Retrofits to spray booths and prep zones with minor adjustments

IR AND UV CURING

- Save time - ready to handle in minutes
- Reliable, precise curing results

BETTER FOR THE ENVIRONMENT

- Low energy spend per vehicle
- No energy waste in between jobs

BETTER FOR YOU

- Always comfortable booth temperature
- Pre-programmed - easy to operate
- Park in a corner, out of your way

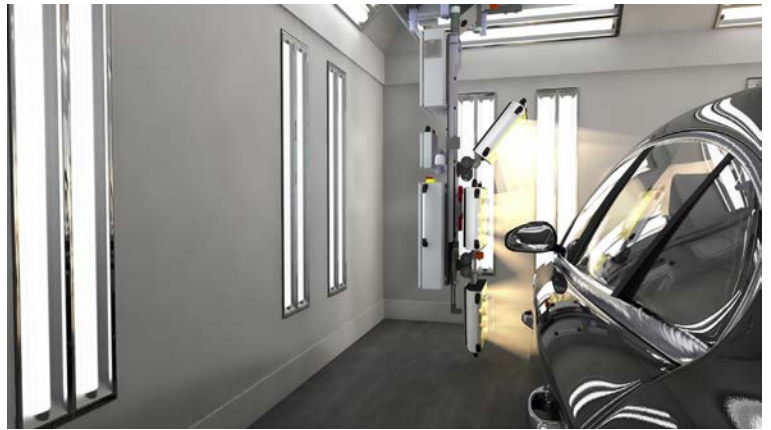

ROBOTIC TRAVEL



AUTOMATED CURING

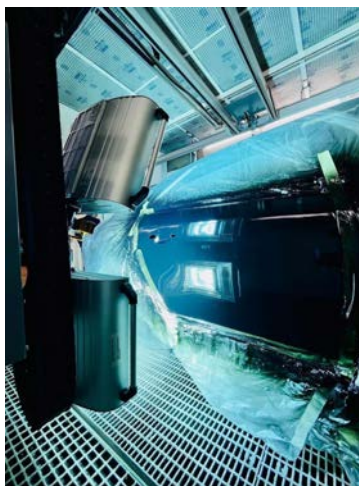

ULTRAVIOLET (UV) CURING



INFRARED (IR) CURING



ENERGY SAVING, ROBOTIC CURING FROM IRT

IRT ICURE

Robotic, all inclusive dryer for booth and prep zone

DYNAMIC AND STATIC CURING

- All you need in one unit
- IR and UV curing
- Preprogrammed recipes for both

TWICE AS POWERFUL

- New HID UV lamps
- 2000 W UV lamp in each cassette
- Cures all UV-activated materials on the market

IRT INFRARED

- Original IRT infrared
- Proven cassette concept

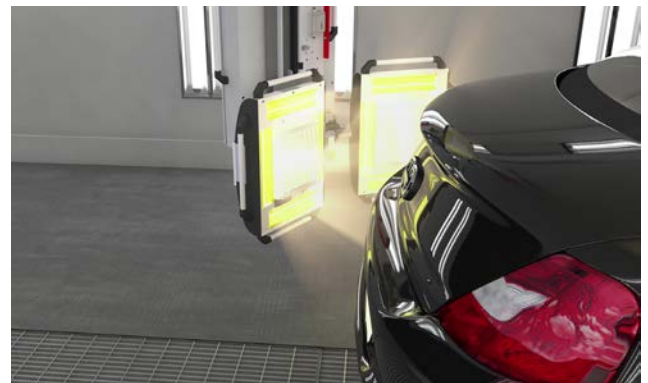

FLEXIBLE CASSETTE ADJUSTMENT

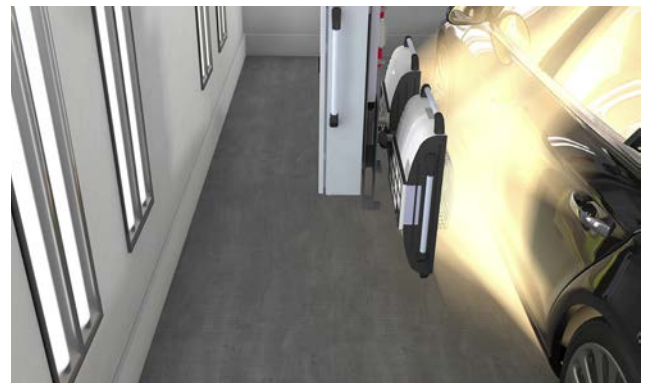

STATIC OPTION

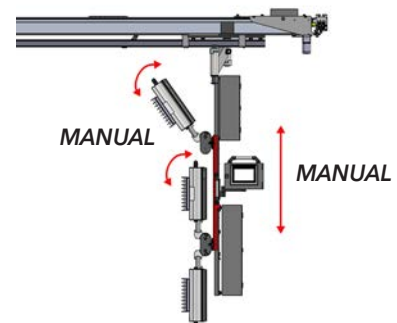
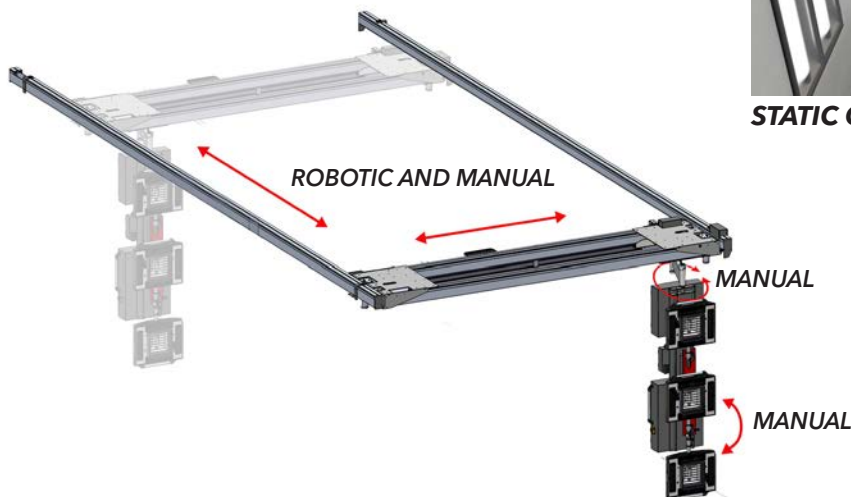

ROBOTIC:

Robotic motion and automated curing on long side or short side

MANUAL:

Rotate and move ICure in the rail system

Rotate cassette position of the two bottom cassettes, 0-90°

Adjust ICure position up/down 0-480 mm



ENERGY SAVING, AUTOMATED DRYING FROM IRT

IRT ICURE

All inclusive booth and prep zone dryer



IRT ICURE						
Art.nr	Nominal frequency	Rated Voltage	Full load curren- cy	Main disconnect fuse	Sound pressure / power level	Ambient temp. (during operation)
ICure 737413	50-60 Hz	400-480 V~3Ph/ PE ± 5%	26 A	32 A	≤ 70 dB (A) at 1 m	Max. 40°C

Robotic motion along the long / short side of the vehicle

Flexible and easy to move into all positions manually

Both dynamic and static drying available

2000 W HID UV-A lamps

Guarded UV safety glass, ozon-free

Plug and Play, preprogrammed and DIY recipes

IR lamps > 20.000 hrs, life time counter for UV lamps

IRT shortwave infrared, >97% effective

Gold coated reflectors determin high efficiency

Time saving and exact drying process



**It's not an arch,
not a half-arch.
It is a new, compact
I-shaped robotic COMBI dryer.
IR and UV curing.**

THE IRT ICURE

IRT IR DRYERS

Basic features

	IRT 1 Prep- Cure	IRT 2 Prep- Cure	IRT 3 Prep- Cure	IRT 4 Prep- Cure	IRT 3-1 PcD	IRT 3-2 PcD	IRT 4-1 PcAuto	IRT 4-2 PcAuto
Even heat distribution	•	•	•	•	•	•	•	•
Short curing times	•	•	•	•	•	•	•	•
Environmentally friendly, efficient use of energy	•	•	•	•	•	•	•	•
24 carat gold coated reflectors with 97% reflection	•	•	•	•	•	•	•	•
Powerful ventilation provides the lamps with a service life of up to 20,000 operating hours	•	•	•	•	•	•	•	•
FreeForm reflectors for an unsurpassed drying surface	•	•	•	•	•	•	•	•
Efficient particle filter that creates a dust-free environment in the cassettes	•	•	•	•	•	•	•	•
Enclosed cassette cables	•	•	•	•	•	•	•	•
The angle of the arm provides increased reach	•	•	•	•	•	•	•	•
The stand is adapted also to dry high cars, e.g. SUVs	•	•	•	•	•	•	•	•
The arm is self-locking in all positions	•	•	•	•	•	•	•	•
Electronic distance sensor	•	•	•	•	•	•	•	•
Self-instructive programs	•	•	•	•	•	•	•	•
Computerized curing process	•	•	•	•	•	•	•	•
12 program pre-sets - 3 custom programs	•	•	•	•	•	•	•	•
Programs for plastic/metal/water/solvent	•	•	•	•	•	•	•	•
18 languages	•	•	•	•	•	•	•	•
Pyrometer for exact temperature control	•	•	•	•	•	•	•	•
Clear display with graphics showing the exact progress of the curing process	•	•	•	•	•	•	•	•
Computerized temperature monitoring of curing process	•	•	•	•	•	•	•	•
Laser circle indicates where temperature measurement takes place	•	•	•	•	•	•	•	•



IRT UV-A DRYERS

Basic features

	UVA 1-3	UVA 1-4	UVA 2-4	IR/ UVA 4-1	IR/ UVA 4-2	SpotCure	SmartCure
Environmentally friendly, efficient use of energy	•	•	•	•	•	•	•
Premium product with long lifetime >5 years	•	•	•	•	•	•	•
Powerful ventilation provides the lamps with a service life of up to 20,000 operating hours				• (IR)	• (IR)	•	•
Low maintenance	•	•	•	•	•	•	•
UV-LED*						•	•
Handheld unit						•	•
Battery operated							•
UV-A wavelength 395 nm						•	•
UV-A wavelength 365 nm						•**	•
High efficiency UV-A pressure lamp	•	•	•	•	•		
UV-A wavelengths 315-395 nm	•	•	•	•	•		
Cures water/solvent based products				•	•		
Programs for plastic/metal/water/solvent				•	•		
Computerized curing process				•	•		

* The range of paint absorption must match the wavelength of irradiated light.

** UV-LED for 365 nm available shortly.

SPARE PARTS

IRT UVA SpotCure	Art. no.
UV/IR Protective glasses	129070
Stand for SpotCure	800805
Timer for SpotCure stand (not for 800802, NA)	712821

IRT UVA SmartCure	Art. no.
UV/IR Protective glasses	129070
Battery 18V Li-ion	715093
Battery charger 18V	715094
Filter	715074
Dust cover	715193
Hard case	800806
Cable for charger (EU plug)	715154
Wall bracket	715129

IRT COMBI IR-UVA	Art. no.
UV/IR Protective glasses	129070
UV lamp replacement kit 400V 1,2 kW	714842
Lamp IR 2 kW 235V 360 U CPL	102699
Lamp IR 1 kW 235V 360 U CPL	102700
Filter cassette assembly w. nylon plugs	713576

IRT UVA X PrepCure X	Art. no.
UV/IR Protective glasses	129070
Air filter	712894
UV lamp replacement kit 230V 1 kW	714599

IRT 1 & 2 PrepCure	Art. no.
IR Lamp 360, 1kW, 230V	102700
Lamp holder LRU3 (M5x16) w. washer	712393
Knob (wing) male M8, for stand	410009
Timer EU 1 PH + PE, for stand	180508

IRT 3 & 4 PrepCure	Art. no.
IR Lamp 360, 1kW, 230V	102700
Lamp holder LRU3 (M5x16) w. washer	712393
Fan 12V DC 92x92 mm	711186
Filter cassette assembly w. nylon plugs	713576
Gas spring 800 N - IRT4 PrepCure	713776
Main switch	420771
Keyboard PrepCure	750496
PCB (Printed Circuit Board) PrepCure	750481
Wheel kit, h=100mm, w=32mm	412364
Solid state relay cpl	126313
Adj bolt with with Nut M12*1,5	120295

IRT 3-X PcD	Art. no.
IR Lamp 360, 1kW, 230V	102700
Lamp holder LRU3 (M5x16) w. washer	712393
Fan Hyperion 12V, w. mesh and plug	714011
Filter cassette assembly w. nylon plugs	713576
Gas spring 850 N - PcD (one cassette)	714060
Gas spring 1400 N (two cassettes)	713614
Solid state relay	750227
Wheel kit, h=134mm, w=32mm	410523
Transformer 230/400/480VAC/12VDC	750630
Display 128x64 points w. lightning	750220
Overlay/keyboard IRT 8 keys	750366
Distance sensor kit 3-1, 3-10 PcD	713737
Distance sensor kit 3-2, 3-20 PcD	713957
PCB (Printed Circuit Board) IRT 3-1 PcD	714012
PCB (Printed Circuit Board) IRT 3-2 PcD	714013

IRT 4-X PcAuto	Art. no.
IR Lamp 360, 1kW, 230V	102700
IR Lamp 360, 2kW, 230V	102699
Lamp holder LRU3 (M5x16) w. washer	712393
Fan Hyperion 12V, w. mesh and plug	714011
Filter cassette assembly w. nylon plugs	713576
Gas spring 850 N (one cassette)	711464
Gas spring 1400 N (two cassettes)	713614
Solid state relay	750227
Wheel kit, h=134mm, w=32mm	410523
Transformer 230/400/480VAC/12VDC	750630
Display 128x64 points w. lightning	750220
Overlay/keyboard IRT 8 keys	750366
Pyrometerkit 4-1 PcAuto	713637
Pyrometerkit 4-2 PcAuto	713864
PCB (Printed Circuit Board) IRT 4-1 PcAuto	714014
PCB (Printed Circuit Board) IRT 4-2 PcAuto	714015



DRESTER GUN CLEANERS - THE ORIGINAL

Outstanding cleaning performance since 1978.
Durable and sustainable solutions.

- Certified and patented products with superior quality
- Swedish inventions satisfying customer needs
- 3 years warranty on diaphragm pumps
- ATEX approved
- Sustainable and durable solutions
- Offering the best working environment
- Manual or Automatic operation
- Approved by major spray gun suppliers

WATER-BORNE

These spray gun cleaners are suitable for water-borne cleaning and they all comply with all paint manufacturers systems regarding cleaning and waste handling.

PAGE 38

SOLVENT BASED

These spray gun cleaners are suitable for solvent based cleaning and they all fit the environment in which a spray gun cleaner operates.

PAGE 39

COMBINATION OF BOTH

These spray gun cleaners are suitable for both solvent-based and water borne cleaning

PAGE 42

APPROVED BY MAJOR
SPRAY GUN SUPPLIERS



Manual



Automatic



Waterborne



Solvent



DRESTER BOXER

Superior gun cleaners to fit all the needs in the workshop

The Drester Boxer series are equipped with a Auto box - a compact, effective and flexible washing compartment - with integrated fluid channels, which makes less-cluttered space. The power of the pump results in more efficient cleaning, meaning that less cleaning solvents are needed per spray gun. The Auto box is located at the back of the unit, allowing a spacious manual washing sink at the front.

A magnetic gun holder pulls the trigger to open the paint channel and fixates a gun in seconds, in one simple step. It fixates the spray gun in a position where the gun's air channels are protected, facing downwards, so there is no risk of solvent entering the air channels.

EQUIPPED WITH SMART AUTO-BOX

PATENTED MAGNETIC GUN HOLDER

3 YEARS WARRANTY ON PUMPS

FOOT-OPERATED PUMPS FOR HANDS-FREE OPERATION



DRESTER CLASSICS

Compact and user-friendly spray gun cleaners with outstanding cleaning performance

The Drester Classics by Hedson have been on the market for decades, which says a lot about their performance and value for the money. They are still very high in demand and remain a reliable choice. It has been dominating the water-borne cleaning market, and with its robustness and user-friendliness it still has no equivalent. The automatic Classics, for solvent, takes gravity-fed guns as well as old-style suction-fed guns.

3 YEARS WARRANTY ON PUMPS

ROUND SINK WITH NO WELDING SEAMS FOR EASY MAINTENANCE

MANUAL AND/OR AUTOMATIC CLEANING

WASHES ALL TYPES OF GUNS - SUCTION OR GRAVITY FED GUNS



DRESTER X-SERIES

Reliable and sustainable spray gun cleaners with excellent cleaning performance

The robust Drester X-series by Hedson are aimed towards workshops and industries with a heavy work load, designed with a welded stainless platform to ensure durable sustainability and a long life. They are designed with a welded stainless platform and washes all types of guns. Includes a compressed air dryer. Chose between manual, automatic or double compartments.

3 YEARS WARRANTY ON PUMPS

ROBUST AND SUSTAINABLE FOR HEAVY WORK LOAD

ADJUSTABLE WASH CYCLE, 1-4 MIN

SPRAY GUN STORAGE, UP TO 7 GUN STORAGE



DRESTER BOXER AQUA

Compact size spray gun cleaner with two working stations

- Automatic and manual cleaning
- Built in filtration and flocculation to reduce waste cost
- Flow-through brush, which is fed with recycled water



DIMENSIONS

Height	1510 mm (59.5")
Width	835 mm (33.0")
Max depth	650 mm (25.5")
Depth at the floor	610 mm (24.0")
Weight	65 kg (140 lb)



DRESTER BOXER AQUA

Compressed air needed	Extraction capacity	Extractor diameter	Part.no.
7-12 bar (110-180 psi) 250 l/min (9 cfm)	140 m ³ /h / 82 cfm (15 m extension) 180 m ³ /h / 106 cfm (5 m extension)	80 mm (3.15")	DB22A (Blue) DI22A (Stainless steel)

DRESTER CLASSIC 1000

Manual spray gun cleaner with brush and high pressure rinse gun

- Prepared for different set-ups depending on paint brand
- Foot operated for hands-free operation
- Built-in waste recycling system



DIMENSIONS

Height	1220 mm (48")
Diameter	Ø 590 mm (23")
Weight	24 kg



DRESTER 1000

Compressed air needed	Flow through brush	Liquid volume of machine	Part.no.
5-12 bar (80-180 psi) 100 l/min (4 cfm)	1,5-2 l/min	35 l / 10 gallons	1000

DRESTER CLASSIC 1050

Manual spray gun cleaner with re-circulating water

- Pre-wash brush and a rinse gun fed with recycled water
- Manual cleaning with brush and high pressure rinse gun
- Quick connect whip line for blowing out the spray gun paint channel



DIMENSIONS

Height	1050 mm (41")
Diameter	Ø 590 mm (23")
Weight	21 kg

DRESTER 1050

Compressed air needed	Flow through brush	Liquid volume of machine	Part.no.
5-12 bar (80-180 psi) 100 l/min (4 cfm)	1,5-2 l/min	35 l / 10 gallons	1050





DRESTER BOXER DOUBLE SOLVENT

Compact size spray gun cleaner with two working stations

- Automatic cleaning with re-circulating solvent
- Equipped with a patented Auto box
- Flow-through brush fed with re-circulation solvent



DIMENSIONS

Height	1510 mm (59.5")
Width	835 mm (33.0")
Max depth	650 mm (25.5")
Depth at the floor	610 mm (24.0")
Weight	75 kg (165 lb)



DRESTER BOXER DOUBLE SOLVENT

Compressed air needed	Ventilation capacity required	Extractor diameter	Part.no.
7-12 bar (110-180 psi) 150 l/min (6 cfm)	500 m ³ /h (310 cfm)	125 mm (5")	DB22S (Blue) DI22S (Stainless steel)

DRESTER BOXER QUATTRO SOLVENT

Full-size spray gun cleaner with four working stations

- Working stations can be used simultaneously
- Equipped with a patented Auto box
- Foot-operated pumps for hands-free operation



DIMENSIONS

Height	1510 mm (59.5")
Width	1185 mm (33.0")
Max depth	650 mm (25.5")
Depth at the floor	610 mm (24.0")
Weight	105 kg (230 lb)



DRESTER BOXER QUATTRO SOLVENT

Compressed air needed	Ventilation capacity required	Extractor diameter	Part.no.
7-12 bar (110-180 psi) 150 l/min (6 cfm) (450 l/min (16 cfm) with DRESTER AIRVENT 11660)	800 m ³ /h (500 cfm)	125 mm (5")	DB44S (Blue) DI44S (Stainless steel)

DRESTER BOXER COMPACT

User-friendly spray gun cleaner with small footprint

- Automatic wash compartment with a automatic/manual clean rinse
- For solvent or water-borne solvent
- Fixed rinse nozzle fed with clean solvent



DIMENSIONS

Height	1830 mm (72")
Width	590 mm (23")
Weight	30 kg (66 lb)

DRESTER BOXER COMPACT 11

Compressed air needed	Ventilation capacity required	Extractor diameter	Clean Rinse	Part.no.
7-12 bar (110-180 psi) 250 l/min (9 cfm)	140 m ³ /h / 82 cfm (15 m extension) 180 m ³ /h / 106 cfm (5 m extension)	180 mm (3.15")	Manual	DC11 (Blue) DC11-I (Stainless steel)
7-12 bar (110-180 psi) 250 l/min (9 cfm)	140 m ³ /h / 82 cfm (15 m extension) 180 m ³ /h / 106 cfm (5 m extension)	180 mm (3.15")	Automatic	DC12 (Blue) DC12-I (Stainless steel)





DRESTER CLASSIC 2600

Efficient and solvent saving manual clean rinse

- Manual cleaning with flow-through brush
- Foot operated for hands-free operation
- Manual clean rinse with venturi nozzle



DIMENSIONS

Height	990 mm (39")
Diameter	Ø 563 mm (22")
Weight	30 kg (66 lb)

DRESTER CLASSIC 2600

Compressed air needed	Ventilation capacity required	Extractor diameter	Part.no.
5-12 bar (80-180 psi) 250 l/min (9 cfm)	140 m³/h / 82 cfm (15 m extension) 180 m³/h / 106 cfm (5 m extension)	125 mm (5")	2600 (Blue) 2600-INOX (Stainless steel)



DRESTER CLASSIC 3600

Automatic spray gun cleaner with manual clean rinse

- Automatic cleaning with re-circulating solvent
- Manual rinse with clean solvent
- Equipped with air pressure regulator and water trap for durability



DIMENSIONS

Height	990 mm (39")
Diameter	Ø 563 mm (22")
Weight	30 kg (66 lb)

DRESTER 3600

Compressed air needed	Ventilation capacity required	Extractor diameter	Part.no.
7-12 bar (110-180 psi) 250 l/min (9 cfm)	140 m³/h / 82 cfm (15 m extension) 180 m³/h / 106 cfm (5 m extension)	125 mm (5")	3600 (Blue) 3600-INOX (Stainless steel)



DRESTER CLASSIC 8000

Automatic spray gun cleaner with automatic and manual clean rinse

- Can be used with conventional or water-based paints
- Automatic cleaning with re-circulating solvent
- Automatic or manual rinse with clean solvent



DIMENSIONS

Height	990 mm (39")
Diameter	Ø 563 mm (22")
Weight	33 kg (73 lb)

DRESTER 8000

Compressed air needed	Ventilation capacity required	Extractor diameter	Part.no.
7-12 bar (110-180 psi) 250 l/min (9 cfm)	140 m³/h / 82 cfm (15 m extension) 180 m³/h / 106 cfm (5 m extension)	125 mm (5")	8000-A 8000-B (with collecting tray base)





DRESTER X-SERIES MANUAL

Manual spray gun cleaner

- One manual wash compartment with re-circulating solvent
- Solvent flow is activated by a foot pedal
- Equipped with a solvent brush and compressed air dryer

DIMENSIONS

Height	1510 mm (59.5")
Width	835 mm (33")
Max. depth	650 mm (25.5")
Depth at the floor	610 mm (24")
Weight	75 kg (165 lb)



DRESTER X-SERIES MANUAL

Compressed air needed	Ventilation capacity required	Extractor diameter	Max. dum size	Part.no.
7-12 bar (110-180 psi) 90 l/min. (3 cfm) 1 pump 370 l/min (14 cfm) incl. AIRVENT 11660 in operation	500 m ³ /h (310 cfm)	125 mm (5")	60 litres	DIX11M

DRESTER X-SERIES AUTOMATIC

Automatic spray gun cleaner

- One automatic wash compartment for solvent or water-borne solvent
- Hand-switch operated
- Equipped with timer and compressed air dryer

DIMENSIONS

Height	1510 mm (59.5")
Width	835 mm (33")
Max. depth	650 mm (25.5")
Depth at the floor	610 mm (24")
Weight	75 kg (165 lb)



DRESTER X-SERIES MANUAL

Compressed air needed	Ventilation capacity required	Extractor diameter	Max. dum size	Part.no.
7-12 bar (110-180 psi) 90 l/min. (3 cfm) 1 pump 370 l/min (14 cfm) incl. AIRVENT 11660 in operation	500 m ³ /h (310 cfm)	125 mm (5")	60 litres	DIX11

DRESTER X-SERIES DOUBLE

Automatic and manual spray gun cleaner

- Automatic wash compartment for solvent or water-borne solvent
- Manual wash compartment cleaning of primer and filler tools, scrapers etc.
- Equipped with timer, solvent brush and compressed air dryer

DIMENSIONS

Height	1510 mm (59.5")
Width	1185 mm (33")
Max. depth	650 mm (25.5")
Depth at the floor	610 mm (24")
Weight	95 kg (209 lb)



DRESTER X-SERIES DOUBLE

Compressed air needed	Ventilation capacity required	Extractor diameter	Max. dum size	Part.no.
7-12 bar (110-180 psi) 180 l/min. (6 cfm) 2 pumps 460 l/min (17 cfm) incl. AIRVENT 11660 in operation	600 m ³ /h (380 cfm)	125 mm (5")	60 litres	DIX22





DRESTER BOXER DOUBLE COMBO

Spray gun cleaner with two working stations

- Automatic wash compartment with integrated fluid channels
- Manual washing sink with a flow-through brush and a clean rinse nozzle
- Pneumatic extractor (Airvent) included



DIMENSIONS

Height	1510 mm (59.5")
Width	1185 mm (33")
Max. depth	650 mm (25.5")
Depth at the floor	610 mm (24")
Weight	65 kg (210 lb)

DRESTER BOXER DOUBLE COMBO

Compressed air needed 7-12 bar (110-180 psi) 250 l/min. (9 cfm)	Ventilation capacity required 140 m³/h / 82 cfm (15 m extension) 180 m³/h / 106 cfm (5 m extension)	Extractor diameter 125 mm (5")	Part.no. DB22C (Blue) DI22C (stainless steel)
--	--	--	--



DRESTER BOXER TRIPLE COMBO

Spray gun cleaner with three working stations

- Automatic wash compartment with integrated fluid channels
- Two manual washing sink with a flow-through brush and a clean rinse nozzle
- Automatic rinsing with clean solvent



DIMENSIONS

Height	1510 mm (59.5")
Width	1185 mm (33")
Max. depth	650 mm (25.5")
Depth at the floor	610 mm (24")
Weight	95 kg (210 lb)

DRESTER BOXER TRIPLE COMBO

Compressed air needed 7-12 bar (110-180 psi) 250 l/min (9 cfm) (450 l/min (16 cfm) with DRESTER AIRVENT 11660)	Ventilation capacity required 500 m³/h (310 cfm)	Extractor diameter 125 mm (5")	Part.no. DB33C (Blue) DI33C (stainless steel)
--	--	--	--



DRESTER BOXER QUATTRO COMBO

Spray gun cleaner with four working stations

- Two automatic wash compartment with integrated fluid channels
- Two manual washing sink with a flow-through brush and a clean rinse nozzle
- Automatic rinsing with clean solvent or water



DIMENSIONS

Height	1510 mm (59.5")
Width	1185 mm (33")
Max. depth	650 mm (25.5")
Depth at the floor	610 mm (24")
Weight	105 kg (230 lb)

DRESTER BOXER QUATTRO COMBO

Compressed air needed 7-12 bar (110-180 psi) 250 l/min (9 cfm) (450 l/min (16 cfm) with DRESTER AIRVENT 11660)	Ventilation capacity required 800 m³/h (310 cfm)	Extractor diameter 125 mm (5")	Part.no. DB44C (Blue) DI44C (stainless steel)
--	--	--	--



DRESTER QUICKRINSE

Efficient and user friendly pneumatic rinsing spray gun cleaner for use with disposable cup systems

The Drester QuickRinse by Hedson has been developed to provide quick, thorough spray gun cleaning for water or solvent paints, especially for use with disposable cup system.

Installation is simple and easy, either with the use of magnets for attachment to the booth or mixing room walls or more permanently with zip screws. Save time by keeping the spray gun cleaner close to the paint job.

- For all disposable cup system
- Perfectly clean spray gun in 10 seconds gives time and cost savings
- High-pressure cleaning for safe colour changes

DRESTER QR-10

Manual spray gun cleaner for water-borne paints

- Can be placed inside the spray booth
- Equipped with a diaphragm pump
- Automatic rinsing with clean solvent or water



DIMENSIONS

Height	645 mm (25.5")
Width	535 mm (21.0")
Depth	263 mm (10.5")
Weight	12,5 kg (27 lb)



DRESTER QR-10

Compressed air needed	Pump capacity	Permitted solvents	Liquid volume of machine	Part.no.
5-12 bar (80-180 psi) 100 l/min (4 cfm)	2 l/min	Water or water-borne solvents	5+5 litre	QR-10

DRESTER QR-20

Manual spray gun cleaner for solvent based paints

- Also designed for cleaning with water, or water-based solvents
- Easy installation anywhere in the workshop



DIMENSIONS

Height	461 mm (18.1")
Width	306 mm (12.1")
Depth	273 mm (10.8")
Weight	6 kg (13.2 lb)



DRESTER QR-20

Compressed air needed	Pump capacity	Permitted solvents	Liquid volume of machine	Part.no.
5-12 bar (80-180 psi) 100 l/min (4 cfm)	2 l/min	Solvent and solvent mixtures	Amount of wash fluid depending on chosen size of container	QR-20

DRESTER QR-TT

Manual spray gun cleaner for both water-borne and solvent based paints

- Can be placed inside the spray booth if water-borne solvents are used
- Easy installation anywhere in the workshop



DIMENSIONS

Height	667 mm (26.3")
Width	565 mm (22.2")
Depth	264 mm (10.4")
Weight	16 kg (32 lb)



DRESTER QR-TT

Compressed air needed	Pump capacity	Permitted solvents	Liquid volume of machine	Part.no.
5-12 bar (80-180 psi) 100 l/min (4 cfm)	2 l/min	LEFT BOX: Water or water-based solvents RIGHT BOX: Solvents and solvent mixtures	3 l/solvent (amount of water depending on chosen size of container)	QR-TT



DRESTER DYNAMIC TRIPLE

Better spray gun cleaning performance with an environmentally friendly closed system of handling solvents

The transfer of the solvents between the spray gun cleaner and the recycler is fully automated; the dirty, heavy and hazardous manual solvent handling is eliminated and at the same time the equipment and floor in the workshop stays clean. Instantly after the transfer of solvents, access to clean solvent in the spray gun cleaner is available.

The system allows for the units to be placed either close together or in separate rooms up to 25 meters (subject to local fire legislation).

The convenient operation of the Drester Dynamic Triple by Hedson system encourages to run the system often.

This keeps the solvent in the spray gun cleaner in better condition, resulting in improved spray gun cleaning performance. The consumption of solvent is reduced, the waste of solvent is kept to a minimum and costs are cut dramatically.

- Reduced solvent consumption
- Improved spray gun cleaning performance
- Fully automated transfer between the spray gun cleaner and the recycler

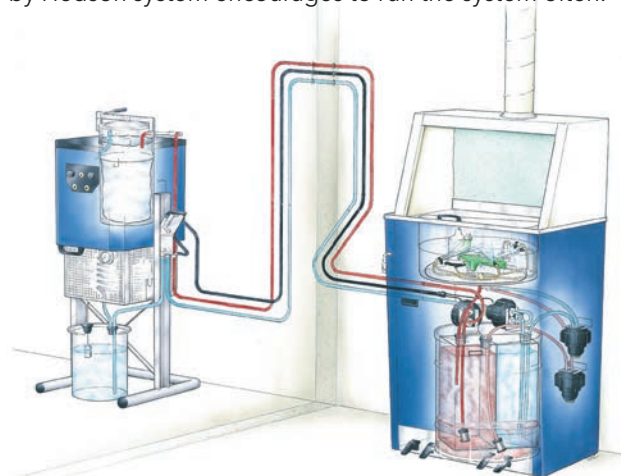

TO SETUP A DRESTER DYNAMIC TRIPLE YOU NEED THE FOLLOWING UNITS

- 1 DRESTER SPRAY GUN CLEANER
- 2 DOCKING UNIT
- 3 RECYCLER

DRESTER RDX - DOCKING UNIT

- For solvent transfer in the Drester Dynamic Triple
- Includes an overflow protection.
- Can be placed inside the spray gun cleaners

DIMENSIONS

Height	590 mm (23")
Width	1610 mm (63")
Max. Depth	120 mm (47")
Weight	67 kg (148 lb)



DRESTER DOCKING UNIT

Compressed air needed	Solvent capacity	Pump capacity	Liquid pressure	Part.no.
Clean, dry air at 3-10 bar	Max. 80 litres	10 l/minutes	2 bar	RDX-8012 Drester 2600, 3600 & 8000 RDX-9012 Drester Boxer Solvent, X-Series Manual

DRESTER 120 - RECYCLER

- A solvent recycler in the Drester Dynamic Triple
- Recovers and recycles the solvent used in the spray gun cleaner
- Can also be used as a stand-alone product

DIMENSIONS

Height	700 mm (17.5")
Diameter	Ø 500 mm (19.5")
Weight	21 kg (46 lb)



DRESTER RECYCLER

Type of solvents distillable	Boiler capacity	Residues discharge	Condensation system	Condensate material	Time/cycle	Voltage	Part.no.
Thinner type	12 litres	Plastic bag	By air	Stainless steel	3-4 hours	200-240 V single Phase 50 or 60Hz	DR-120-A

DRESTER WASTE MANAGEMENT

Safe and efficient way to get rid of paint residues and waste in the workshop

- Two compartments for easy separation of waste
- Equipped with two funnels with grids, for cans to be left to drain
- Flexible usage



DRESTER WM-90-1
Two compartments for liquid waste



DRESTER WM-90-2
One compartment for liquid and one for solid waste



DRESTER WM-90-3
Two compartments for solid waste



DRESTER WASTE MANAGEMENT

Compressed air needed	Extractor flange diameter	Part.no.
7-12 bar (110-180 psi) 450 l/min (16 cfm) (if extraction is desired)	125 mm (5") with flange (part.no. 10187)	WM-90-1 WM-90-2 WM-90-3

DIMENSIONS

Height	1025 mm (40")
- with hood	1470 mm (58")
- with hood & airvent	2230 mm (89")
Width	780 mm (31")
Depth at the floor	570 mm (23")
Weight	42 kg (x lb)

DRESTER MIXING TABLE

Keeps the mixing room structured

- Smart storage which gives efficient work flow
- Basic model with one shelf underneath
- Available in powder coated or stainless finish



DRESTER MIXING TABLE

Airvent diameters	Weight	Width	Height	Max. depth	Part.no.
14010 Ø100 mm	Basic model	30,0 kg	1200 mm	Basic model 930 mm	MT-120 (powder coated)
14020/14040 Ø125 mm	with slot extraction & airvent	36,5 kg		With slot extraction 1110 mm	
	with hood & airvent	45,0 kg		With hood 1470 mm	
				Working height 905 mm	

HERKULES LACKY TABLE

Table with a lot of storage space suitable for the mixing room

- Storage space for painting materials and tools
- Lowered working surface
- Outflow tunnel and optimum solvent extraction



HERKULES LACKY TABLE

Width	Overall Height	Depth	Part.no.
1200 mm	1395 mm	650 mm	LT-05 ¹
1800 mm	1395 mm	650 mm	LT-06 ¹

¹ Paper roll holder and extraction system available as accessories.



DRESTER SPRAY GUN CLEANERS

Basic features

	SOLVENT		AQUA	COMBO			COMPACT	
	DB22S	DB44S	DB22A	DB22C	DB33C	DB44C	DC11	DC12
Unique magnetic gun holder, patent approved	•	•	•	•	•	•	•	•
Hands-free operation, foot-pedal operated	•	•	•	•	•	•	•	•
Optimized placements of nozzles, for superior cleaning	•	•	•	•	•	•	•	•
Funnel for blow-out	•	•	•	•	•	•	•	•
Air gun for drying	•	•	•	•	•	•	•	•
Air supply line	•	•	•	•	•	•	•	•
3-year pump warranty	•	•	•	•	•	•	•	•
Available with stainless cabinet	•	•	•	•	•	•	•	•
ATEX category	2	2	2	2	2	2	2	2
Automatic cleaning with re-circulating solvent	•	•		•	•	•	•*	•
Automatic rinsing with clean solvent	•	•			•	•		•
Automatic cleaning with re-circulating water-borne solution			•			•	•*	
Automatic rinsing with clean water			•			•		
Flow-through brush fed with re-circulating solvent	•	•			•	•		
Flow-through brush fed with re-circulating water-borne solution			•	•	•	•		
Hand-held rinse nozzle fed with clean solvent	•	•			•	•		
Fixed rinse nozzle fed with clean solvent				•			•	•
Hand-held rinse nozzle fed with clean water			•	•	•	•		
Pneumatic extractor (Airvent) included			•	•			•	•
Extraction hood; use Airvent, Minivent or central extraction	•	•			•	•		
No. of pumps	2	4	2	2	3	4	1	2
Can be connected to Drester recycler through a Docking unit (RDX)	•	•		•**	•	•	•	•
Rinse gun for high pressure water cleaning of paint channels			•	•	•	•		
Rinse gun can be set up to be fed with recycled water or tap water			•			•		
Optional tap water kit, to feed tap water through rinse gun				•	•			
Automatic agitation when flocculating			•	•	•	•		
Dual filter system for unsurpassed efficiency when recycling water			•	•	•	•		
Automatic evacuation of filtrate container			•			•		

* DC11 can be used for automatic cleaning with either solvent or waterborne solvent, such as Drester AquaSolve
 ** RDX must be placed outside of the cabinet



DRESTER SPRAY GUN CLEANERS

Basic features

	CLASSIC					X-SERIES		
	1000	1050	2600	3600	8000	Manual	Auto	Double
Manual wash with re-circulating solvent/recycled water	•	•	•			•		•
Manual clean rinse	•	•	•	•	•	•	•	•
Foot-pedal operated						•		
Hand-switch operated							•	•
Air connection and funnel for spray out			•	•	•	•	•	•
Air gun for drying spray gun		•	•			•	•	•
Extraction unit (Airvent) included			•	•	•	DIX11M-A	DIX11-A	DIX22-A
Number of pumps	1	1	1	1	2	1	1	2
3-year warranty on diaphragm pumps	•	•	•	•	•	•	•	•
Can be connected to Drester 120 with the Docking Unit RDX			•	•	•	•	•	•
Can be used with water-borne paints	•	•			•	•	•	•
Specifically adapted for all water-borne paint systems	•	•						
Cleaning brush	•	•	•			•	•	•
Rinse gun with nozzle for high pressure cleaning of paint channel	•	•						
Automatic agitation during flocculation	•	•						
Dual filter system for separation of paint sludge	•	•						
Automatic evacuation of filtrate container	•							
Nozzle for quick cleaning of paint channels			•					
ATEX category	3	3	2	2	2	2	2	2

DRESTER CONSUMABLES



FILTERS	
Part.no.	R8701 - Main filter (standard) R8702 - Pre-filter (always to be used) Delivered in 5 pcs.
TO BE USED IN FOLLOWING DRESTER GUN CLEANERS	
Part.no.	Description
DB22A	Drester Boxer Aqua
DB22C	Drester Boxer Double Combo
DB33C	Drester Boxer Triple Combo
DB44C	Drester Boxer Quattro Combo
1000	Drester Classics 1000
1050	Drester Classics 1050

AQUASOLVE	
Part.no.	230120 Delivered in 1 L x 12 pcs
TO BE USED IN FOLLOWING DRESTER GUN CLEANERS	
Part.no.	Description
DB22A	Drester Boxer Aqua
DB22C	Drester Boxer Double Combo
DB33C	Drester Boxer Triple Combo
DB44C	Drester Boxer Quattro Combo
1000	Drester Classics 1000
1050	Drester Classics 1050
QR-10	Drester QuickRinse, water
QR-TT	Drester QuickRinse, water & solvent

FLOCCULATION POWDER	
Part.no.	9211 Delivered in can / 1,5 kg.
TO BE USED IN FOLLOWING DRESTER GUN CLEANERS	
Part.no.	Description
DB22A	Drester Boxer Aqua
DB22C	Drester Boxer Double Combo
DB33C	Drester Boxer Triple Combo
DB44C	Drester Boxer Quattro Combo
1000	Drester Classics 1000
1050	Drester Classics 1050

NEW!

DRESTER

NEW - COMING SOON

ANOTHER **FIRST** FROM DRESTER

Ace Gun cleaners



- **CAPTURE@SOURCE VENTILATION**
- **ALL STAINLESS COMPARTMENT**
- **MAGNETIC SPRAY GUN HOLDER**
- **UNRIVALLED CLEANING PERFORMANCE**



HERKULES LIFTING EQUIPMENT

Why choose a Herkules lift?

Pneumatic technology

- Faster than hydraulic systems
- Silicone- & oil free to prevent damages to paint jobs
- No electricity needed

Ergonomic working process

- 85% of damages are located beneath the window, so lifting is always an ergonomic advantage
- Stepless lifting heights - safe and smooth

Advanced flexibility

- Lifting on wheels, lifting on chassis or a combination of both
- Installation on-ground, in-ground or integration in existing rail systems
- Mobile lifts or transport system for lifts

Optimized efficiency

- Fast lifting and transport of vehicles
- Optimal view on damages for best repair quality
- Yearly checks of lifts can be done by owner

High-quality engineering

- User-friendly
- Robust and durable due to 40 years of experience
- Easy to install in the workshop

Qualified technical customer support

- Contact for technical service
- Spare parts even for older lifts

LIFTING ON WHEELS

These lifts are wheel supported for easy access to damaged areas on the vehicles.



LIFTING ON CHASSIS

These lifts are chassis supported for a wheel free operation.



COMBINATION OF BOTH

These lifts are a combination of both wheel and chassis supported lifts, one lift - two possibilities.

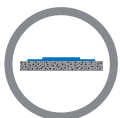

ON-GROUND

Simply fix with screws and dowels, and the lift is ready for immediate use.



IN-GROUND

In-ground installation to concrete or grids.



ON-RAILS

Integration in existing rail system



HERKULES AIRGOMATIC HLS 3213

For ergonomic lifting of all common vehicle model

- 3.2 tons lifting capacity
- 1300 mm lifting height
- For a wheelbase up to 3500 mm
- Fold-down driveover ramps

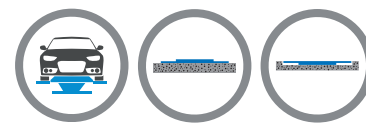

DIMENSIONS

Lifting height (on-ground/in-ground)	1300 / 1140 mm
Overdrive height (on-ground)	110 mm
Pit depth (in-ground)	160 mm

HERKULES AIRGOMATIC HLS 3213

Part.no.	Loading capacity	Air supply	Wheelbase (min/max)	Lifting time	Lowering time	Weight	Installation
HLS 3213-11	3.2 tons	8 bar	1600/3500 mm	approx. 25 sec*	approx. 30 sec*	925 kg	On-ground
HLS 3213-14	3.2 tons	8 bar	1600/3300 mm	approx. 25 sec*	approx. 30 sec*	865 kg	In-ground
HLS 3213-16	3.2 tons	8 bar	1600/3300 mm	approx. 25 sec*	approx. 30 sec*	865 kg	In-ground, CE-stop**
HLS 3213-17	3.2 tons	8 bar	1600/3500 mm	approx. 25 sec*	approx. 30 sec*	950 kg	Transmobile (HLT-06)

* With empty lift

**Safety stop with audible alarm to prevent foot injuries

HERKULES HLS 1200

A compact lift for space-saving requirements

- 2.5 tons lifting capacity
- Easy to install in the workshop
- Stepless lifting heights for ergonomic working position

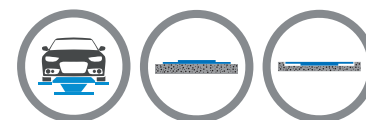

DIMENSIONS

Lifting height (on-ground/in-ground)	930 / 805 mm
Overdrive height (on-ground)	110 mm
Pit depth (in-ground)	125 mm

HERKULES AIRGOMATIC HLS 3213

Part.no.	Loading capacity	Air supply	Wheelbase (min/max)	Lifting time	Lowering time	Weight	Installation
HLS 1200-11	2.5 tons	8 bar	1500/3200 mm	approx. 25 sec*	approx. 30 sec*	750 kg	On-ground
HLS 1200-14	2.5 tons	8 bar	1500/3000 mm	approx. 25 sec*	approx. 30 sec*	750 kg	In-ground
HLS 1200-16	2.5 tons	8 bar	1500/3000 mm	approx. 25 sec*	approx. 30 sec*	750 kg	In-ground, CE-stop**
HLS 1200-17	2.5 tons	8 bar	1500/3200 mm	approx. 25 sec*	approx. 30 sec*	800 kg	Transmobile (HLT-3)

* With empty lift

**Safety stop with audible alarm to prevent foot injuries



HERKULES AIRGOMATIC 3213 DUO

Adaptive lift for most diverse requirements

- 3.2 tons lifting capacity
- 1300 mm lifting height
- Lifting on wheel or on chassis

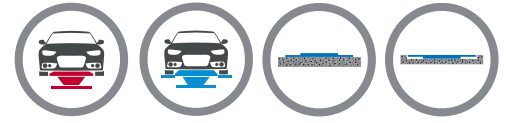

ALTERNATIVELY



DIMENSIONS

Lifting height (on-ground/in-ground)	1300 / 1140 mm
Overdrive height (on-ground)	110 mm
Pit depth (in-ground)	160 mm

HERKULES AIRGOMATIC 3213 DUO

Part.no.	Loading capacity	Air supply	Wheelbase (min/max)	Lifting time	Lowering time	Weight	Installation
HLS 3213-DUO-11	3.2 tons	8 bar	1600/3500 mm	approx. 25 sec*	approx. 30 sec*	1050 kg	On-ground
HLS 3213-DUO-14	3.2 tons	8 bar	1600/3300 mm	approx. 25 sec*	approx. 30 sec*	955 kg	In-ground
HLS 3213-DUO-16	3.2 tons	8 bar	1600/3300 mm	approx. 25 sec*	approx. 30 sec*	955 kg	In-ground, CE-stop**
HLS 3213-DUO-17	3.2 tons	8 bar	1600/3500 mm	approx. 25 sec*	approx. 30 sec*	1070 kg	Transmobile (HLT-06)

* With empty lift
**Safety stop with acoustic audible to prevent foot injuries

HERKULES HLS 1200 DUO

User-friendly and variable lift even for confined spaces

- 2.5 tons lifting capacity
- Lifting on wheel or on chassis
- Installation on ground or in ground

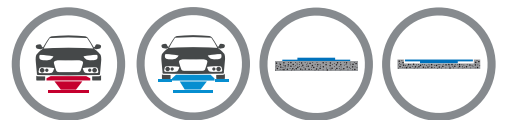

DIMENSIONS

Lifting height (on-ground/in-ground)	930 / 825 mm
Overdrive height (on-ground)	110 mm
Pit depth (in-ground)	115mm

HERKULES HLS 1200 DUO

Part.no.	Loading capacity	Air supply	Wheelbase (min/max)	Lifting time	Lowering time	Weight	Installation
HLS 1200-DUO-11	2.5 tons	8 bar	1500/3200 mm	approx. 25 sec*	approx. 30 sec*	850 kg	On-ground
HLS 1200-DUO-14	2.5 tons	8 bar	1500/3000 mm	approx. 25 sec*	approx. 30 sec*	850 kg	In-ground
HLS 1200-DUO-16	2.5 tons	8 bar	1500/3000 mm	approx. 25 sec*	approx. 30 sec*	850 kg	In-ground, CE-stop**
HLS 1200-DUO-17	2.5 tons	8 bar	1500/3200 mm	approx. 25 sec*	approx. 30 sec*	850 kg	Transmobile (HLT-03)

* With empty lift
**Safety stop with audible alarm to prevent foot injuries



HERKULES HLQ

Lift for existing rail system*

- for transportation between spraying and drying booths

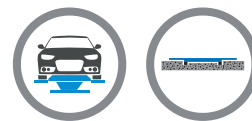

- Lifting on wheels
- Vehicles can be moved sideways
- Installation in-ground



*Trolleys for railsystem not included

HERKULES HLQ

Part.no.	Loading capacity	Air supply	Lifting height	Installation
HLQ 01	2.5 tons	8 bar	800 mm	in-ground
HLQ-3213	3.2 tons	8 bar	1300 mm	in-ground

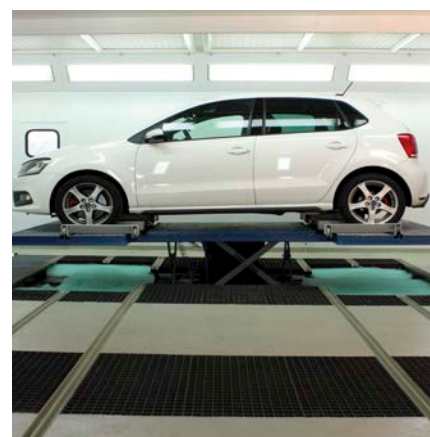



HERKULES HM 1100

A fast and space saving lift

- 2.8 tons lifting capacity
- Horizontal moveable swivel arms - safe fixing of wide vehicles
- No installation - ready to use immediately
- Movable with an optional shaft

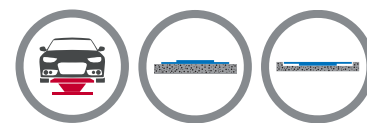

DIMENSIONS

Lifting height (in-ground/onground)	930/825 mm
Overdrive height (on-ground)	115 mm
Pit depth (in-ground)	115 mm

HERKULES HM 1100

Part.no.	Loading capacity	Air supply	Lifting time	Lowering time	Weight	Installation
HM 1100-01	2.8 tons	8 bar	approx. 15 sec*	approx. 20 sec*	510 kg	On-ground
HM 1100-04	2.8 tons	8 bar	approx. 15 sec*	approx. 20 sec*	510 kg	In-ground, with 4 rubber blocks 800-105

* With empty lift

HERKULES K700

A versatile lift for tire service workshops

- 2.8 tons lifting capacity
- No installation - ready to use immediately
- The swivel arms reach easily the vehicle's original lifting points

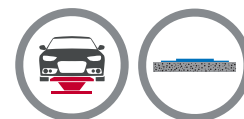

DIMENSIONS

Lifting height	930 mm
Overdrive height	110 mm
Weight	840 kg

HERKULES K700

Part.no.	Loading capacity	Air supply	Lifting time	Lowering time	Installation
K 700-45	2.8 tons	8 bar	approx. 15 sec*	approx. 20 sec*	On-ground

* With empty lift



HERKULES LIFTS BY HEDSON

Basic features

	AirgoMatic 3212-11	AirgoMatic 3212-14 / AirgoMatic 3212-16		AirgoMatic 3212-17	AirgoMatic 3212-DUO-11	AirgoMatic 3212-DUO-14 / AirgoMatic 3212-DUO-16		AirgoMatic 3212-DUO-17	HLS 1200-11	HLS 1200-14 / HLS 1200-16		HLS 1200-17	HLS 1200-DUO-11	HLS 1200-DUO-14 / HLS 1200-DUO-16		HLS 1200-DUO-17	HLQ.01	HM 1100-01	HM 1100-04	K700-45
SCOPE OF DUTIES																				
Paint- and body work	•	•	•	•	•	•	•	•	•	•	•	•	•	•	•	•	•	•	•	•
Tirework					•	•	•						•	•	•			•	•	•
DRIVING SPECIFICATIONS																				
Wheelbase min (cm)	180	180	180	180	180	180	180	180	180	180	180	180	160	160	160					
Wheelbase max (cm)	350	330	350	350	330	350	320	300	320	320	300	320	320	300	320					
Drive over possibility	(•)	•	(•)	(•)	•	(•)	(•)	•	(•)	(•)	•	(•)	(•)	•	(•)			•	•	•
LIFTING SPECIFICATIONS																				
Chassis supported					•	•	•						•	•	•			•	•	•
Wheel supported	•	•	•	•	•	•	•	•	•	•	•	•	•	•	•			•	•	•
TECHNICAL SPECIFICATIONS																				
Lifting Capacity (tons)	3.2	3.2	3.2	3.2	3.2	3.2	2.5	2.5	2.5	2.5	2.5	2.5	2.5	2.5	2.5			2.5	2.8	2.8
Overdrive height (cm)	12		12	12		12	11		11	11		11	11		11			11		11
Pit depth (cm)		15			15			11			11				11			10		11
Lifting height (cm)	130	115	130	130	115	130	93	82	93	93	82	93	93	82	93			75	93	82
Air supply, bar (min/max)	6/8	6/8	6/8	6/8	6/8	6/8	6/8	6/8	6/8	6/8	6/8	6/8	6/8	6/8	6/8			6/8	6/8	6/8
INSTALLATION SPECIFICATIONS																				
In-ground		•			•			•			•			•					•	•
On-ground	•		•	•		•	•		•		•		•		•			•	•	•
Mobile			•			•						•			•				(•)	
On-rail																		•		

Standard •
Optional (•)



HERKULES AIRGOMATIC 3213 AND HERKULES AIRGOMATIC 3213 DUO FOR TRANSMOBILE

Flexible solution for the workshop

- 3.2 tons lifting capacity
- Flexible usage at different workstations



HERKULES TRANSMOBILE FOR AIRGOMATIC

Part.no.	Loading capacity	Drive	Remote control
HLT 06	3.2 tons	24 V	Yes

HERKULES AIRGOMATIC 3213 AND HERKULES AIRGOMATIC 3213 DUO FOR TRANSMOBILE

Part.no.	Loading capacity	Air supply	Wheelbase (min/max)	Lifting time	Lowering time	Weight	Installation
HLS 3213-17	3.2 tons	8 bar	1600/3500 mm	approx. 25 sec*	approx. 30 sec*	950 kg	Transmobile (HLT-06)
HLS 3213-DUO-17	3.2 tons	8 bar	1600/3500 mm	approx. 25 sec*	approx. 30 sec*	1070 kg	Transmobile (HLT-06)

* With empty lift

HERKULES HLS 1200 AND HERKULES HLS 1200 DUO FOR TRANSMOBILE

Agile solution even for small workshops

- 2.5 tons lifting capacity
- Flexible usage at different workstations



HERKULES TRANSMOBILE FOR HLS 1200

Part.no.	Loading capacity	Drive	Remote control
HLT 03	2.5 tons	24 V	Yes

HERKULES HLS 1200 AND HERKULES HLS 1200 DUO FOR TRANSMOBILE

Part.no.	Loading capacity	Air supply	Wheelbase (min/max)	Lifting time	Lowering time	Weight	Installation
HLS 1200-17	2.5 tons	8 bar	1500/3000 mm	approx. 25 sec*	approx. 30 sec*	800 kg	Transmobile (HLT-03)
HLS 1200-DUO-17	2.5 tons	8 bar	1500/3000 mm	approx. 25 sec*	approx. 30 sec*	850 kg	Transmobile (HLT-03)

* With empty lift



HERKULES TRANSMOBILE

Better workshop utilization - move the vehicles through tight spaces in the workshop safe and easy

Herkules Transmobile creates new working capacity due to a safer and quicker work routine and drastically reduces the work involved in vehicle transportation around the workshop.

The Herkules Transmobile is a mobile unit, which can safely transport the lifts - with or without vehicles - around the workshop. The Transmobile is operated with a remote control and can be used in any workshop with a level surface, even in the spray booth with grid floor.

- Reduces vehicle transportation times
- Easy transportation of electric vehicles without batteries
- Powerful self-drive with no harmful exhaust gases
- Vehicle stays masked during transportation between workstations

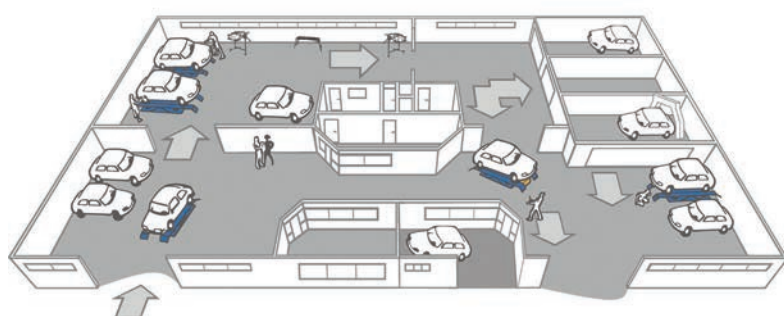

HERKULES TRANSMOBILE

Part.no.	Loading capacity	Drive	Remote control
HLT 06 ¹	3.2 tons	24 V	Yes
HLT 03 ²	2.5 tons	24 V	Yes

1) Suitable for Herkules 3213 AirgoMatic and 3213 Airgomatic Duo
2) Suitable for Herkules HLS 1200 and HLS 1200 Duo

DIMENSIONS

Height (HLT06 / HLT03)	456 / 456 mm
Length (HLT06 / HLT03)	2600 / 2319 mm
Width (HLT06 / HLT03)	1488 / 1450 mm
Wheelbase (HLT06 / HLT03)	1919 / 1583 mm
Weight (HLT06 / HLT03)	680 / 600 kg

HERKULES PAINTER

Safe passanger lift for all kind of works around the vehicle, suitable in the prep area and spray booth

Herkules Painter secure a safe standing and ergonomic working position for the painters when working at higher vehicles like trucks or busses.

The wheels on the lift make it easy to move around in the workshop. Due to its construction, the lift is excellent for small spaces in the prep area as well as in the spray booths.

On the platform of the lift there are several air supplies as well as storage space for the tools, therefore they are always within reach.

- Smooth lifting and lowering
- Excellent for small spaces
- Safe working position
- Smart tool storage on the platform



HERKULES PAINTER

Part.no.	Loading capacity	Air supply	Working height	Platform dimensions	Trolley base
Painter-01	150 kg	8 bar	3.25 m	2000x674 mm	2060x906 mm
Painter-02	150 kg	8 bar	4.00 m	3500x674 mm	3677x1116 mm
Painter-04	150 kg	8 bar	4.00 m	2000x674 mm	2153x1200 mm
Painter-05	250 kg	8 bar	4.00 m	3500x674 mm	3677x1525 mm





WORKSHOP EQUIPMENTS

Increase the productivity - organize the work in the workshop for a safer and more efficient work process

HERKULES LACKY TENDER

The perfect carrying and storage system in the workshop

- Cushioned rack for bulks
- Safety fixation with tension belt
- Continuous extractable bearings

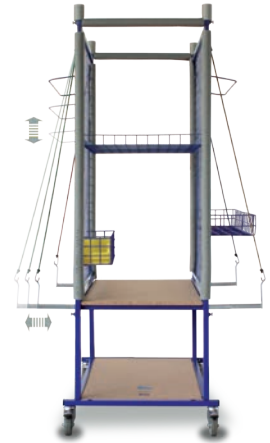

HERKULES LACKY TENDER

Part.no.	Lenght	Width	Height	Weight
300-297	900 mm	680 mm	2020 mm	45 kg

HERKULES LACKY BUMPER

Safe storage and easy transportation of bulky vehicle parts

- Padded shelves
- Adjustable in many ways
- Easy to rank



HERKULES LACKY TENDER

Part.no.	Lenght	Width	Height	Weight
300-399	1200 mm	800 mm	2000 mm	28 kg

HERKULES STEP-BENCH

Ideal when painting the roofs of large vehicles such as vans and small trucks

- Space-saving
- Low weight
- Easy to put away



HERKULES STEP-BENCH

Part.no.	Loading capacity	Weight	Dimensions
300-257	120 kg	5,0 kg	1000x330x325 mm
		6,5 kg	1190x330x600 mm

HERKULES PAINT STAND

Quick and safe painting- and assembly stand for the workshop

- Wide range of adjustments
- Robust but easy to handle
- Extendable



HERKULES PAINT STAND

Part.no.
BL-01



DRESTER WHEEL WASHERS

Outstanding cleaning performance with low water consumption
Durable and sustainable solutions

A Drester wheel washer is the perfect piece of equipment for levelling up to a truly professional tire handling. The advantages are obvious - clean wheels, satisfied customers and a cleaner shop. Increase the service level and earn more money!

- Short payback time
- Intelligent heating system
- Gentle & fast cleaning method
- Programmable wash cycles, time controlled heater
- Low water & energy consumption
- Huge time and labours savings
- Improved customer service and increased net savings
- Heat insulating and impact resisting HPE water tank

GRANULE CLEANING METHOD

The Drester granule cleaning method has the best cleaning performance in the shortest time on the market. Two carefully selected kinds of plastic granules with optimal features clean the tire and rim efficiently yet gentle. Most kinds of rims can be cleaned in a Drester wheel washer.

EASY TO USE AND ERGONOMIC

The Drester wheel washers are very easy to use, using mainly symbols in the user interface. The advanced software enables editable settings and customized washing programs. In order to save the operator's back and reduce absences due to back problems, the ergonomic Drester wheel washers can be equipped with a patented, integrated lift or a wheel loading system on the fully automatic machine.



DRESTER GP 24 LE MANS

Advanced and fully automatic wheel washer



- **Payback time 14 months - washing 8000 wheels/year, charging €2,50/wheel**
- Load the wheels on a trolley, dock it to the wheel washer and push the start button
- Washes most kinds of alloy and SUV wheels

DRESTER GP 24 LE MANS					WHEEL DIMENSIONS	
Compressed air needed	Air consumption	Air flow	Power supply	Part.no.	Wheel width	135-350 mm (5-14")
8-12 bar (120-174 psi)	400 litre/wash cycle	1000 litre/min. at 7 bar	400V, 3~, 50 Hz, 16 A	GP241-AK ³	Wheel diameter	540-800 mm (22-31")
³⁾ Incl. in delivery: 2 trolleys, 20 kg (44lbs) of DoublePower Granules, Heater, Granule Basket, CleanRinse, Granule Filter					Max Wheel Weight	45 kg (99 lbs)

UNIT DIMENSIONS		WATER CONSUMPTION AND TIME	
Measures (WxDxH)	1620x1100x1550 mm (64x43x61")	Water volume	300 liter
Height, open lid	2360 mm (93")	Water consumption	1 litre/washed wheel
Weight of unit	320 kg (704 lbs) ²	Cleaning time/ wheel ⁴	Adjustable settings from 25-155 sec settings when delivered 25, 50, 75, 100 sec
Weight of trolley	56 kg/trolley	Clean rinse	0.3 litre/wheel

²⁾ without water or DoublePower

⁴⁾ Dry blowing not included

OPTIONS & ACCESSORIES	
Water Cleaning	230350
Trolley/Docking unit	230556
Granule Filter	230508

CONSUMABLES	
Double power granules	230794
Hose Filter	R12038
Basket Filter	R12037
Flocculation Powder	R12076
Detergent BIO 291	BIO-291



DRESTER GP 12 SILVERSTONE

Premium wheel washer with outstanding cleaning performance

- Dynamic flush pipe for fast and efficient cleaning
- **Payback time 13 months - washing 4000 wheels/year and charging €2,50/wheel**
- Good for cleaning high polished alloy rims, big tires



DRESTER GP 12 SILVERSTONE

Compressed air needed	Air consumption	Air flow	Power supply	Part.no.
8-12 bar (120-174 psi)	400 litre/wash cycle	1000 litre/min. at 7 bar	400V, 3~, 50 Hz, 16 A	WD12304-AD1

³⁾ Incl. in delivery: 1 rubber mat, 20 kg (44 lbs) of DoublePower Granules, Heater, Granule Basket

WHEEL DIMENSIONS

Wheel width	145-360 mm (6-15")
Wheel diameter	540-860 mm (22-34")
Max Wheel Weight	60 kg (132 lbs)

UNIT DIMENSIONS

Measures (WxDxH) with QuickLift	1081x1201x1489 mm (43x47x59")
	1153x1226x1489 mm (45x48x59")
Weight of unit	240 kg (530 lbs) ²⁾
Weight of QuickLift	26 kg (60 lbs)

²⁾ Without water or DoublePower

WATER CONSUMPTION AND TIME

Water volume	310 liter
Water consumption	1 litre/washed wheel
Cleaning time/ wheel ⁴⁾	Adjustable settings from 25-155 sec settings when delivered 25, 50, 75, 100 sec
Clean rinse	0.3 litre/wheel

⁴⁾ Dry blowing not included

OPTIONS & ACCESSORIES GP10 & GP12

Water Cleaning	230350
Clean Rinse	230357
Quick Lift	230315
Granule Filter	230508

DRESTER GP 10 MONZA

Efficient wheel washer with fantastic cleaning performance

- Fixed flush pipes for rational and efficient cleaning
- **Payback time 10 months - washing 4000 wheels/year and charging €2,50/wheel**
- Suitable for standard tires



DRESTER GP 10 MONZA

Compressed air needed	Air consumption	Air flow	Power supply	Part.no.
8-12 bar (120-174 psi)	400 litre/wash cycle	1000 litre/min. at 7 bar	400V, 3~, 50 Hz, 16 A	WD10302-AD1

³⁾ Incl. in delivery: 1 rubber mat, 20 kg (44 lbs) of DoublePower Granules, Heater, Granule Basket

WHEEL DIMENSIONS

Wheel width	145-360 mm (6-15")
Wheel diameter	540-860 mm (22-34")
Max Wheel Weight	60 kg (132 lbs)

UNIT DIMENSIONS

Measures (WxDxH) with QuickLift	1081x1201x1489 mm (43x47x59")
	1153x1226x1489 mm (45x48x59")
Weight of unit	230 kg (510 lbs) ²⁾
Weight of QuickLift	26 kg (60 lbs)

²⁾ Without water or DoublePower

WATER CONSUMPTION AND TIME

Water volume	310 liter
Water consumption	1 litre/washed wheel
Cleaning time/ wheel ⁴⁾	Adjustable settings from 25-155 sec settings when delivered 30, 60, 90, 120 sec
Clean rinse	0.3 litre/wheel

⁴⁾ Dry blowing not included



DRESTER W-450 POWERWASH

Compact and powerful wheel washer for every workshop

- Fixed nozzle flush pipes
- **Payback time 16 months - washing 2000 wheels/year and charging €2,50/wheel**
- Cleaning of all kinds of wheels



DRESTER W-450 POWERWASH

Compressed air needed	Air consumption	Air flow	Power supply	Part.no.
8-12 bar (120-174 psi)	400 litre/wash cycle	1000 litre/min. at 7 bar	400V, 3~, 50 Hz, 16 A 230V, 3~, 50 or 60 Hz, 32 A	W-450-1AD

³⁾ Incl. in delivery: 1 rubber mat, 20 kg (44 lbs) of DoublePower Granules, Heater, Granule Basket

UNIT DIMENSIONS

Measures (WxDxH)	1140x1005x1450 mm (45x39.5x57")
Weight of unit	220 kg (704 lbs) ²⁾

²⁾ Without water or DoublePower

OPTIONS & ACCESSORIES W-450

Water Cleaning	230812
Clean Rinse	14830
Granule Filter	230508

WATER CONSUMPTION AND TIME

Water volume	210 liter
Water consumption	1 litre/washed wheel
Cleaning time/ wheel ⁴⁾	30, 60, 90, 120 sec

⁴⁾ Dry blowing not included

WHEEL DIMENSIONS

Wheel width	135-305 mm (5-12")
Wheel diameter	560-800 mm (22-31")
Max Wheel Weight	45 kg (99 lbs)

DRESTER WHEEL WASHERS BY HEDSON

Standard features and equipment

	GP24	GP12	GP10	W-450
Intelligent Heater	●	●	●	
Immersion Heater				●
Granule Filter	●			
Granule Basket	●	●	●	●
Rubber mat		●	●	●
Clean Rinse	●			
Phase recognition	●	●	●	
Auto Start		●	●	
Adjustable washing programs	●	●	●	
Trolleys/Docking Unit	●			
Quicklift (option)		●	●	
Double Power Granules (20 kg, 44 lbs)	●	●	●	●
Prepared for water cleaning	●	●	●	●



DRESTER GP FILTER eQ

Integrated water purification system. Reduces 50% of water consumption and filters up to 97% of all particles. Cost saving and easy to handle.

With the GP Filter eQ filtration unit, it is possible to wash up to 5000 wheels without changing the water while remaining a low water consumption per washed wheel. The efficiency and the work-flow in the shop are improved and the handling is made easier. The Drester GP Filter eQ filtration unit is fully integrated with the software of the Drester wheel washers (the GP and W-750 models), which ensures an easy, user-friendly and reliable cleaning method. The GP Filter eQ water purification method fulfills authority demands for a proper waste water treatment.

Clean wheels with a clean conscience!



ARTICLES IN FILTER VERSIONS

Clean Rinse Retrofit (GP10, 12)	230357
Clean Rinse Kit (W-450)	13630
GP24 Kit eQ	231142
W750 Kit eQ	231213

CONSUMABLES

Floculation Powder, 5kg	R12076
Filter Bags eQ, 15 pcs	231210

ACCESSORIES

Filter Drain Hose Extension 5m eQ	231141
WW Drain Hose Extension 5m eQ	13630
Drain Box eQ	231143
Retrofit / Transfer Kit eQ	231140

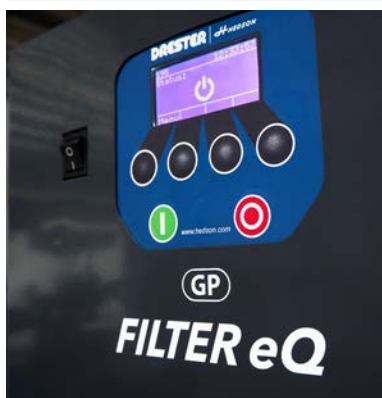

WASTE WATER CLEANING CYCLE

1. Wastewater is pumped from the wheel washer to the filter unit.
2. Inside the filter unit, a flocculating and filtering process separates the waste sludge from the water.
3. Ultimately purified water is directed to a drain.

DIMENSIONS

Height	1884 mm
Width	700 mm
Depth	597 mm
Weight	85 kg

DRESTER GP FILTER eQ

Compressed air needed	Air consumption	Air flow	Power supply	Works with	Part.no.
8-12 bar (120-174 psi)	50 litre/wash cycle	1000 litre/min. at 7 bar	230V, 10 A	Drester GP 10/12/24 and W-750 ¹	231000 / 231000-T

¹⁾ The wheel washer must be equipped with clean rinse to work with the filter unit. Clean Rinse can be retrofitted. BIO-291 detergent can not be used with Hedsons GP Filter eQ. No other detergents may be used in Drester wheel washers.

²⁾ Incl. in delivery: 5 m Drain Hose, 5 m Water Hose, 5 kg Floculation Powder, 15 pcs Filter Bags

WE ARE HERE FOR YOU!

Customer Service

Orders

General inquiries

Technical support

Orders (DE)

General inquiries (DE)

Technical support (DE)

order.a@hedson.com

info@hedson.com

support@hedson.com

bestellung@hedson.com

info.de@hedson.com

service.de@hedson.com

Sales - Germany, Austria, Switzerland and the Netherlands

Jos Keijenberg, Sales leader & NL

Alex Kohl, West

Michael Eismann, Northeast

Hans-Joachim Draband, North

Hans-Juergen Dollmann, DE Southwest & CH

Sven Janssen, Southeast & AT

jos.keijenberg@hedson.com

alex.kohl@hedson.com

michael.eismann@hedson.com

hans-joachim.draband@hedson.com

hans-juergen.dollmann@hedson.com

sven.janssen@hedson.com

Sales - France

Cedric Desmettre

Daniel Jorge

cedric.desmettre@hedson.com

daniel.jorge@hedson.com

Sales - USA & Canada

Mike Bertrand

Shelley Featherstone

Colin Hammacott

mike.bertrand@hedson.com

shelley.featherstone@hedson.com

colin.hammacott@hedson.com

Sales

Niklas Johansson, Sales Leader

Eva Löfgren, Nordics and Baltics

Magnus Lojander, Nordics & UK

Janusz Deneka, Eastern Europe

Carlos Herrera, Spain & Portugal

Juan Alloza, Asia/South Pacific, Latin America

niklas.johansson@hedson.com

eva.lofgren@hedson.com

magnus.lojander@hedson.com

janusz.deneka@hedson.com

carlos.herrera@hedson.com

juan.alloza@hedson.com