



IRT CURING





IRT CURING EQUIPMENT

Save space, time and money

A wide selection of high-quality, user-friendly, space saving short-wave infrared (IR) and ultraviolet (UV-A) IRT dryers.

A combination of 50+ years of curing know-how, high-end parts, sophisticated software and inhouse/third party/user tests will cure your material 100%, every time.

IRT mobiles and rail dryers provide reliable, high quality results with advanced curing technology that is easy to use. They are designed for the workshop, to save floor space and speed up the repair job process.

IRT provides maximum productivity in the body shop, always considering health and safety regulations.

- Controlled heat distribution
- Large curing areas
- Short curing times

IR CURING, DRY IN MINUTES

IRT IR dryers use gold coated reflectors for superior heat transfer management.

PAGE 4

UV-A CURING, DRY IN SECONDS

IRT UV-A dryers have an outstanding intensity, developed in cooperation with market leading paint manufacturers.

PAGE 10

IF YOU WANT IT ALL

The combination of IR and UV-A curing makes our IRT COMBI range unique.

PAGE 18

Gold coated reflectors	Infrared	Ultraviolet UV-A	Ultraviolet UV-A LED	Wear UV safety glasses	Powerful ventilation	Mobile dryer	Rail dryer	Distance control for preset programs	Non-contact temp. monitor	Battery operated	Cord operated	Handheld



IR HANDHELD & MOBILE DRYERS

Efficient, safe and quick IR drying

Handheld and IRT mobile dryers that cure all base coat and paint materials. Easy access with flexible arms that are easy to adjust.

HIGH-EFFICIENCY REFLECTORS

ADVANCED, USER FRIENDLY SOFTWARE

PAGE 4



UV-A HANDHELD & MOBILE DRYERS

High quality UV-A curing for all workshops

IRT UV-A curing with high intensity in a variety of models. Battery operated and handheld UV-A LED models and UV-A high efficiency pressure lamp mobiles.

OUTSTANDING INTENSITY

HIGH QUALITY DURABLE UV-A CURING

PAGE 10



RAIL DRYERS

Space savers with improved workflow

IRT Rail dryers are wall- and ceiling installations for prep stations and spray booths with IR- and/or UV-A availability from all angles.

NO LOOSE CABLES

MAINTENANCE FREE

PAGE 21



ARCH DRYERS

Improved throughput of vehicles in the workshop

In-booth and prep station curing that saves energy, time and space. IRT Arch dryers automatically move and identify the chosen car panel, using only the corresponding IR-lamps necessary.

CURES VEHICLES AND LOOSE PANELS

FULLY AUTOMATIC AND EASY TO USE

PAGE 24



IRT INFRARED CURING

Careful consideration of bodyshop heating requirements

To provide the best heat transfer possible, all IRT infrared (IR) dryers are equipped with unique gold coated reflectors.

IRT reflectors provide a superior heat distribution and a large curing area. Short-wave IR provides full heat immediately and penetrates deep into the paint. The paint cures from the inside and out without retaining solvents and moisture.

Heat loss to the air is minimal and all energy is transferred to the surface. IRT IR dryers irradiate the object and do not heat the surrounding air, thereby minimizing energy losses.

- Efficient use of energy
- Short drying times
- Large curing area
- High quality curing results

IRT CURING TIMES

Putty	5-6 min
Filler, bright/dark	7-15 min
Water based paint	4-6 min
Base coat	4-8 min
Top/clear coat, plastic filler	4-15 min
Plastic top/clear coat, soft cure	5-17 min
Final boost	2-4 min

The curing time is extremely short. Times above apply to the PcAuto range. Add a minute or two for other models.

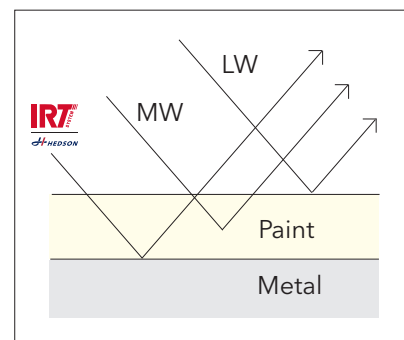

SIMPLIFIED DIAGRAM

Short-wave heat cures from the inside and out without retaining solvents and moisture.



ADVANCED AUTOMATIC DISTANCE AND TEMPERATURE CONTROL.

Look for these symbols for temperature measurement (pyrometer), laser circle and digital distance sensor. The surface temperature is continuously measured and the effective output regulated in a split second for optimal curing results.





IRT 1

Use handheld or attach to a stand (optional), for minor paint and panel work

- One lamp - output power 1 kW
- Gold coated reflector
- Best curing at 30 cm from the surface

DIMENSIONS

Handheld (LxHxD)	418x196x66 mm
Handheld weight	1,8 kg
Stand (HxW)	1450x350 mm
Stand weight	10 kg
Curing area*	0,17 m ²

* Curing area at a distance of 30 cm

IRT 1 PREPCURE, HANDHELD

Part no.	Current	Output power	Fuse	Voltage	Frequency
800429	4 A	1 kW	10 A	230V, 1 PH, EU	50-60 Hz
800624	4 A	1 kW	10 A	230V, 1 PH, UK (UK plug)	50-60 Hz
800431	4 A	1 kW	10 A	230V, 1 PH, AUS & ARG type 1	50-60 Hz
800432	9 A	1 kW	15 A	100V, 1 PH, JP	50-60 Hz
800428	9 A	1 kW	15 A	110V, 1 PH, NA (not ETL)	50-60 Hz
800524	9 A	1 kW	15 A	110V, 1 PH, NA ETL (fixed on stand - no timer)	50-60 Hz

STAND FOR IRT 1

Part no.	Voltage	
800460	230V, 1PH, EU	Stand with timer
800598	-	Stand without timer



IRT 2

Use handheld or attach to a stand (optional), for minor paint and panel work

- Two lamps - output power 2 kW
- Gold coated reflectors
- Best curing at 40-60 cm from the surface

DIMENSIONS

Handheld (LxHxD)	411x206x147 mm
Handheld weight	2,8 kg
Stand (HxW)	1450x350 mm
Stand weight	10 kg
Curing area*	0,44 m ²

* Curing area at a distance of 60 cm

IRT 2 PREPCURE, HANDHELD

Part no.	Current	Output power	Fuse	Voltage	Frequency
800433	9 A	2 kW	13 A	230V, 1 PH, EU	50-60 Hz
800625	9 A	2 kW	13 A	230V, 1 PH, UK (UK plug)	50-60 Hz
800472	9 A	2 kW	13 A	230V, 1 PH, AUS & ARG type 1	50-60 Hz
800434	9 A	2 kW	15 A	240V, 1 PH, NA ETL (fixed on stand - no timer)	50-60 Hz

STAND FOR IRT 2

Part no.	Voltage	
800460	230V, 1PH, EU	Stand with timer
800598	-	Stand without timer





IRT 3

Dryer adjustable in vertical position

- One cassette with 3 IR lamps
- Digital timers - flash off/full bake 30 + 30 minutes
- Settings will remain after power off

DIMENSIONS

Stand height	1531 mm
Cassette vertical range (height)	88-1300 mm
Width	694 mm
Weight	23 kg
Curing area*	1,0 x 1,1 m

* Curing area at a distance of 60 cm, on black sheet metal



IRT 3 PREPCURE

Part no.	Current	Output power	Fuse	Voltage	Frequency
800610	13 A	3 kW	16 A	230V, 1 PH, EU	50-60 Hz
800473	13 A	3 kW	13 A	230V, 1 PH, UK (UK plug)	50-60 Hz
800474	13 A	3 kW	16 A	230V, 1 PH, AUS & ARG type 1	50-60 Hz
800612	13 A	3 kW	20 A	230V, 1 PH, NA ETL	50-60 Hz

IRT 4

Dryer adjustable in both vertical and horizontal positions

- One cassette with 3 IR lamps, max height 2150 mm
- Digital timers - flash off/full bake 30 + 30 minutes
- Settings will remain after power off

DIMENSIONS

Stand height	1574 mm
Cassette vertical range (height)	160-2150 mm
Width	1188 mm
Weight	46 kg
Curing area*	1,0 x 1,1 m

* Curing area at a distance of 60 cm, on black sheet metal



IRT 4 PREPCURE

Part no.	Current	Output power	Fuse	Voltage	Frequency
800611	13 A	3 kW	16 A	230V, 1 PH, EU	50-60 Hz
800443	13 A	3 kW	13 A	230V, 1 PH, UK (UK plug)	50-60 Hz
800617	13 A	3 kW	16 A	230V, 1 PH, AUS & ARG type 1	50-60 Hz
800615	13 A	3 kW	20 A	230V, 1 PH, NA ETL	50-60 Hz



IRT 3-1

Standard dryer with process control

- One cassette with 3 IR lamps
- Computerized curing process, 12 preset and 3 custom programs
- Electronic distance sensor signals correct distance to curing surface

DIMENSIONS

Stand height	1435 mm
Cassette vertical range (height)	80-2550 mm
Width	1230 mm
Weight	53 kg
Curing area*	1,0 x 1,1 m

* Curing area at a distance of 60 cm, on black sheet metal

IRT 3-1 PCD

Part no.	Current	Output power	Fuse	Voltage	Part no.
800450	4 A	3 kW	10 A	400V, 3 PH, 4-pin, EU	50-60 Hz
800451	4 A	3 kW	10 A	400V, 3 PH, 5-pin, EU	50-60 Hz
800447	8 A	3 kW	10 A	230V, 3 PH, EU	50-60 Hz
800483	4 A	3 kW	10 A	400V, 3 PH, AUS	50-60 Hz
800467	13 A	3 kW	20 A	230V, 1 PH, NA ETL	50-60 Hz



IRT 3-2

Efficient curing for all types of paint materials

- Two cassettes - each with 3 IR lamps
- Computerized curing process, 12 preset and 3 custom programs
- Electronic distance sensor signals correct distance to curing surface

DIMENSIONS

Stand height	1435 mm
Cassette vertical range (height)	80-2550 mm
Width	1230 mm
Weight	62 kg
Curing area*	2,0 x 1,1 m

* Curing area at a distance of 60 cm, on black sheet metal

IRT 3-2 PCD

Part no.	Current	Output power	Fuse	Voltage	Frequency
800453	9 A	6 kW	16 A	400V, 3 PH, 4-pin, EU	50-60 Hz
800454	9 A	6 kW	16 A	400V, 3 PH, 5-pin, EU	50-60 Hz
800459	15 A	6 kW	16 A	230V, 3 PH, EU	50-60 Hz
800455	9 A	6 kW	16 A	400V, 3 PH, AUS	50-60 Hz
800484	15 A	6 kW	16 A	200V, 3 PH, 4P, JP	50-60 Hz
800458	26 A	6 kW	30 A	230V, 1 PH, NA ETL	50-60 Hz





ADVANCED AUTOMATIC DISTANCE AND TEMPERATURE CONTROL:

Pyrometer temperature measurement with laser circle indicator and digital distance sensor. The surface temperature is continuously measured and the effective output regulated in a split second for optimal curing results. Also allows for 3-step drying cycles.

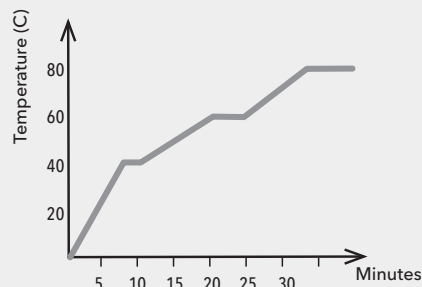

Example of a 3-step drying cycle, used for panel bonding and construction glues etc.



IRT 4-1 & 4-2 PCAUTO

High output dryer, easy to use with advanced curing technology, up to 110°C/230°F

- Automatic temperature control and distance measuring
- 15 process programs (3 customizable)
- Laser circle indicates where temperature measuring takes place
- Electronic distance sensor signals correct distance to curing surface

DIMENSIONS	IRT 4-1	IRT 4-2
Stand height	1450 mm	1450 mm
Cassette vertical range (height)	80-2500 mm	80-2500 mm
Width	1230 mm	1230 mm
Weight	53 kg	62 kg
Curing area*	1,1 x 1,5 m	2,2 x 1,5 m

*Curing area at a distance of 60 cm, on black sheet metal



IRT 4-1 PCAUTO

Part no.	Current	Output power	Fuse	Voltage	Frequency
800423	9 A	6 kW	10 A	400V, 3 PH, 4-pin, EU	50-60 Hz
800425	9 A	6 kW	10 A	400V, 3 PH, 5-pin, EU	50-60 Hz
800421	15 A	6 kW	16 A	230V, 3 PH, EU	50-60 Hz
800426	9 A	6 kW	10 A	400V, 3 PH, AUS	50-60 Hz
800485	15 A	6 kW	16 A	200V, 3 PH, 4P, JP	50-60 Hz
800422	26 A	6 kW	30 A	230V, 1 PH, NA ETL	50-60 Hz
800468	15 A	6 kW	16 A	230V, 3 PH, NA ETL	50-60 Hz
800427	9 A	6 kW	10 A	400V, 3 PH, AUS	50-60 Hz
800613	13 A	6 kW	20 A	440-480V, 2PH, 3P, NA ETL	50-60 Hz

IRT 4-2 PCAUTO

Part no.	Current	Output power	Fuse	Voltage	Frequency
800418	16 A	12 kW	16 A	400V, 3 PH, 4-pin, EU	50-60 Hz
800400	16 A	12 kW	16 A	400V, 3 PH, 5-pin, EU	50-60 Hz
800413	30 A	12 kW	32 A	230V, 3 PH, EU	50-60 Hz
800415	30 A	12 kW	32 A	200V, 3 PH, 4P, JP	50-60 Hz
800417	16 A	12 kW	16 A	400V, 3 PH, AUS	50-60 Hz
800411	48 A	12 kW	50 A	230V, 1 PH, NA ETL	50-60 Hz
800414	30 A	12 kW	30 A	230V, 3 PH, NA ETL	50-60 Hz
800419	16 A	12 kW	20 A	440-480V, 3 PH, NA ETL	50-60 Hz
800614	26 A	12 kW	30 A	440-480V, 2 PH, NA ETL	50-60 Hz

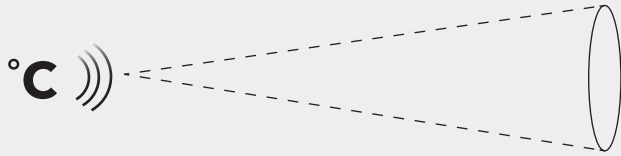

PCAUTO:

Place 60 cm from curing surface.
Laser circle sample area is Ø 30 cm (pyrometer ratio 1:2).
The pyrometer determines an average temperature reading in this area.

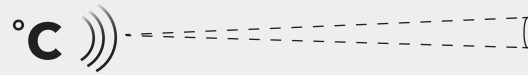

DTP:

Place 40-60 cm from curing surface.
Laser circle sample area is Ø 3-4 cm (pyrometer ratio 1:15).
The pyrometer determines an average temperature reading in this area.



IRT HIGH TEMPERATURE DRYERS

For spot repair and curing of paint material up to 200°C/390°F

- Automatic temperature control and distance measuring
- 15 process programs (customizable)
- Cures typical spot repair, A-B-C pillars and thicker steel materials



IRT 424 DTP 4-1



IRT 464 DTP 4-2

IRT HIGH TEMP DRYERS

Cassette	Drying surface (LxH)	No. of cassettes	No. of lamps	Power
IRT 4 HI-BAKE	300x300 mm	1	3	3 kW
IRT 424 DTP 4-1	400x300 mm	1	2	4 kW
IRT 424 DTP 4-2	1000x300 mm	2	4	8 kW
IRT 425 DTP 4-1	500x300 mm	1	2	4 kW
IRT 425 DTP 4-2	1200x300 mm	2	4	8 kW
IRT 428 DTP 4-1	800x300 mm	1	2	6 kW
IRT 428 DTP 4-2	1800x300 mm	2	4	12 kW
IRT 464 DTP 4-1 (6 kW)	600x600 mm	1	6	6 kW
IRT 464 DTP 4-1 (10 kW)	600x600 mm	1	6	10 kW
IRT 464 DTP 4-2 (12 kW)	1200x600 mm	2	12	12 kW
IRT 464 DTP 4-2 (20 kW)	1200x600 mm	2	12	20 kW

Please contact your local retailer or IRT sales contact for assistance with a suitable IRT DTP dryer.



IRT 4 HI-BAKE

HiBake is a *MANUAL* alternative to the DTP model, with 50% flash-off, 100% fullbake.



ULTRAVIOLET (UV-A) CURING

UV-A dryers with outstanding curing performance

All IRT UV-A models have an outstanding intensity to achieve the best curing result, even curing thick filler layers.

IRT UV-A high efficiency pressure lamp mobiles are equipped with one or two 1000 W UV-A lamps which cure UV-A material in just a few minutes. The ozone-free lamps and protective glass filters out the UV-B and UV-C radiation. A safety switch prevents the lamps from igniting if the glass breaks. Our UV-A LED models are extremely efficient, curing UV-A primer and filler in seconds.

- Outstanding intensity
- High-quality and durable curing
- Developed with market leading paint manufacturers

HANDHELD MODELS, UV-A LED

Battery- and cord operated models available in 365 nm and 395 nm. High-intensity, flexible and precise UV-A LED curing for specific wavelengths.

MOBILE MODELS, UV-A PRESSURE LAMPS

Mobile, long-life, low maintenance, high efficiency UV-A curing with large curing area.

SAFE UV-A CURING

Third party UV safety report (EN62471) for operator safety. UV-LED modules and low pressure bulbs are installed safely behind protective glass. Ozone-free low pressure bulb lamp design.

SAFETY FIRST

Always use UV safety glasses when handling UV-A light. We supply a pair with each delivered unit.

IRT
SYSTEM

IRT UVA 1-3

Curing with high efficiency UV-A lamps

- Curing on vertical surfaces
- One UV-A lamp with protective glass
- Curing time is regulated with an electronic timer

IRT UVA 1 PREPCURE 3

Part no.	Power	Fuse	Voltage	Frequency
800604	1 kW UV-A	10 A	230V, 1 PH, EU	50-60 Hz
800668	1 kW UV-A	10 A	230V, 1 PH, AUS & ARG type 1	50-60 Hz
800671	1 kW UV-A	15 A	230V, 1 PH, NA	50-60 Hz

DIMENSIONS

Stand height	1531 mm
Cassette vertical range (height)	60-1310 mm
Width	694 mm
Weight	60 kg
Curing area*	1,0 x 1,0 m

* At a distance of 55 cm



IRT UVA 1-4

High-quality, durable UV-A curing

- Flexible stand enabling curing of roofs on vehicles
- One UV-A lamp with protective glass
- Curing time is regulated with an electronic timer

DIMENSIONS

Stand height	1448 mm
Cassette vertical range (height)	35-2200 mm
Width	1224 mm
Weight	65 kg
Curing area*	1,0 x 1,0 m

* At a distance of 55 cm



IRT UVA 1 PREPCURE 4

Part no.	Power	Fuse	Voltage	Frequency
800621	1 kW UV-A	10 A	230V, 1 PH, EU	50-60 Hz
800669	1 kW UV-A	10 A	230V, 1 PH, AUS & ARG type 1	50-60 Hz
800672	1 kW UV-A	15 A	230V, 1 PH, NA	50-60 Hz

IRT UVA 2-4

Large curing area with two UV-A lamps

- Flexible stand enabling curing of roofs on vehicles
- Two UV-A lamps with protective glass
- Curing time is regulated with an electronic timer

IRT UVA 2 PREPCURE 4

Part no.	Power	Fuse	Voltage	Frequency
800622	2 kW UV-A	10 A	230V, 1 PH, EU	50-60 Hz

DIMENSIONS

Stand height	1448 mm
Cassette vertical range (height)	35-2200 mm
Width	1224 mm
Weight	81 kg
Curing area*	1,8 x 1,0 m

* At a distance of 55 cm

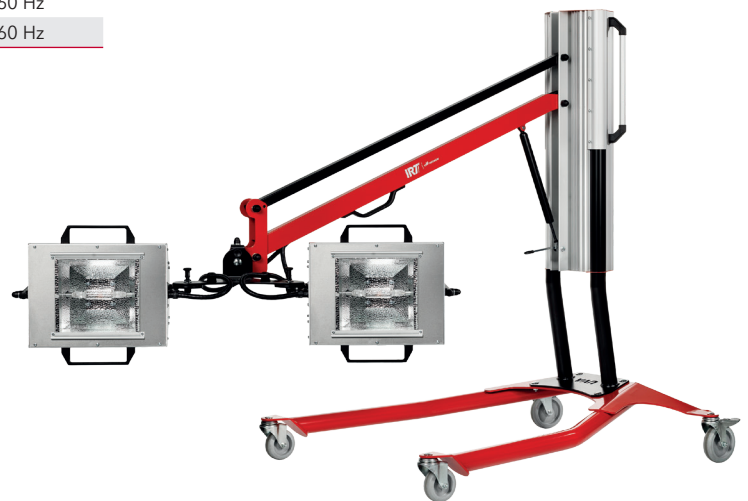



IRT UV-A LED CURING

WHY UV-A LED CURING?

UV-A curing with Light-Emitting Diodes (LED) generates, near-instant curing intensity, cold curing the painted surface without heating up the surrounding air.

Overall maintenance is reduced and the elimination of a warm-up cycle reduces technician down time.

WHAT IS A PHOTO INITIATOR (PI)*?

The energy in the UV-A light polymerizes and cures the UV-A material. The chemical reaction is triggered by a photo initiator and the speed of the process is determined by the energy or intensity of the UV-A light source and the wavelength.

WHY THIRD PARTY INSPECTION?

Third party testing confirms that a product exceeds quality, safety, sustainability and performance of applicable standards for a global product.

Two independent 3rd party inspectors (RISE and Intertek) review our products and our user instructions.

BENIFITS OF INDUSTRY COOPERATION?

By working closely with major paint manufacturers, crucial user experience and expectancy are added to our product development.

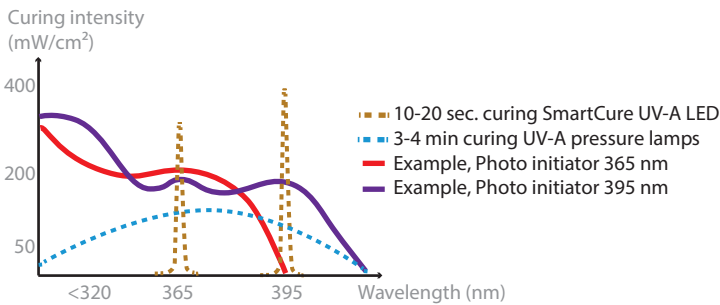

*Illustrating the correlation between PI wavelength, curing speed and UV-A light intensity.



SmartCure is available in wavelength alternatives 365/395 nm, based on paint manufacturer requests. It is prepared for future adaptations and can be retrofitted from 395 nm to 365 nm.

100% CURED

Non-fluctuating curing cycle

The key to high quality, reliable results is in maintaining a non-fluctuating intensity through the complete curing cycle.

Therefore, measuring and comparing light intensity is tricky, showing only a moment of truth. Once the primer/filler surface is sealed, you need to rely on the inside being cured.

With IRT, a combination of curing know-how, high-end parts, sophisticated software and inhouse/third party/user tests will cure your material 100%, every time.

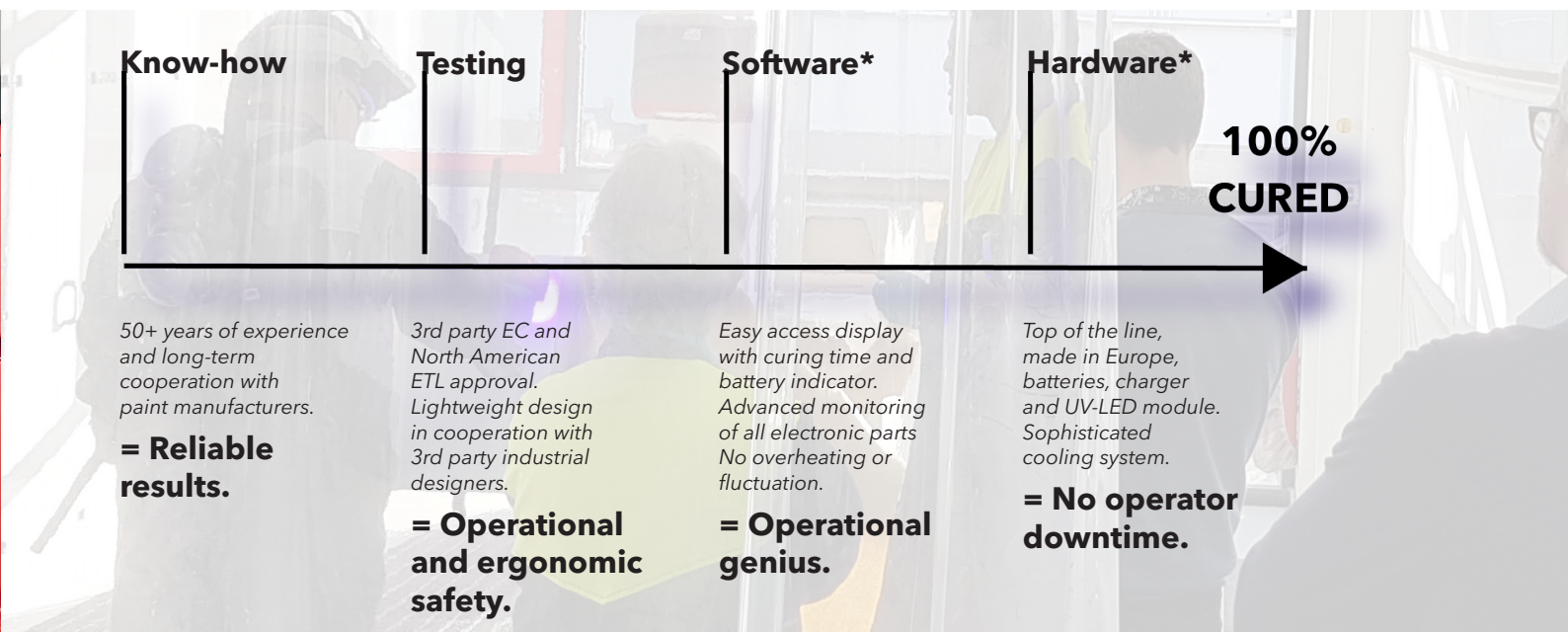

*Example, SmartCure

IRT TESTING

We have tested UV-A fillers, primers and clear coats from every major paint manufacturer and offer solutions for all.

Flexible handheld/fixed cord solutions for the static work place. Battery operated lightweight handheld options for accessibility that eliminates downtime in the work shop.

Our UV-A LED options are available for 365 nm and 395 nm.

IRT UV-A

We have long experience in a leading position on the international curing and drying market.

Our UV-A range of products for body shops and manufacturing industries comes in all shapes, super light handheld tools and easy positioned heavy duty mobiles.

Also checkout IRT's range of UV-A pressure lamps combined with IRT infrared technique, available as mobiles and rail systems for a wider UV-A spectrum.



IRT UV SMARTCURE

200 W UV-A LED battery operated curing

SmartCure comes with two exchangeable batteries and cures UV-A filler and primer in seconds, available for 365 nm/ 395 nm.

IRT UV SmartCure has an extremely powerful output, offering market leading peak/average light intensity.

By combining a powerful UV-LED-module, advanced cooling technology and light weight batteries, reliable, highly effective, non-fluctuating UV-curing is achieved.

Advanced electronics minimizes the risk of machine damage by active ventilation and by monitoring the temperature of both electronics and LED-module. This provides safe operation with efficient steady state voltage LED-output and current control regulation.

- Available for 365 nm/ 395 nm
- Weighs just 1 kg, for excellent work comfort
- High intensity is constant until battery is at 0%



ELIMINATE DOWNTIME

With two exchangeable 18V lithium-ion batteries and 45 minute charging time, IRT UV SmartCure is always available.

RELIABLE CURING RESULTS

By working closely with leading paint manufacturers IRT enables reliable paint processes in all bodyshops.

ULTIMATE CURING GUIDE

To obtain peak performance, work at appr 100 mm from surface.
 @ filler/primer thickness 80-120 µm,
 Ø 160 mm is cured in appr 10 sec.
 (Peak light intensity >350 mW/cm², average >250 mW/m²).



WALL BRACKET
Magnetic wall bracket, included as standard.



DUST COVER
Optional protective dust cover with magnets, art no 715193.



UNIQUE BEAM SPREAD
24 pieces of domed LED's create a unique beam spread over the complete curing area.



HARD CASE*
Optional heavy-duty case, art no 800806.



CARDBOARD BOX*

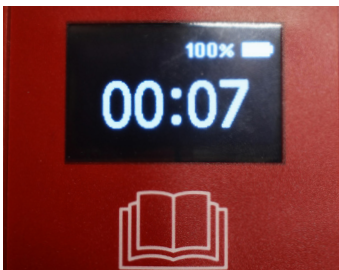

DISPLAY GUIDES THE WAY
All fillers, primers and clear coats have different curing cycles.



LOW MAINTENANCE
Replaceable filter protects electronics inside, art nr 715074.

SUPER LIGHT AND ERGONOMIC
Tested to withstand high impact. Flame resistant plastic shell reinforced with 25% glass fiber and 3 mm scratch and solvent resistant tempered safety glass. Light-weight comfort and easy to use with a precise trigger switch.



DETAILS

Battery type	18 V Lithium-ion
Weight, IRT UV SmartCure + 1 battery	1,16 kg
Dimensions, IRT UV SmartCure + 1 battery (WxHxD)	189x250x88 mm

IRT UV SMARTCURE

Part no.	Article	Current, SmartCure / Charger	Power	Voltage (Battery charger)	Risk Group EN 62471	Frequency
715070-X*	SmartCure 395 nm	8A/2A	200 W	100-240 V	(RG-3)	50-60 Hz
715365-X*	SmartCure 365 nm	8A/2A	200 W	100-240 V	(RG-3)	50-60 Hz

2 batteries, charger, magnetic wall bracket and UV Safety glasses included in delivery. Ambient temp max 40° C.

* SmartCure 395 nm alternatives:
EU; in cardboard box 715070-1 / EU; in hard case 715070-2
NA; in cardboard box 715070-3 / NA; in hard case 715070-4
UK; in cardboard box 715070-5 / UK; in hard case 715070-6
JP; in cardboard box 715070-7 / JP; in hard case 715070-8
AUS; in cardboard box 715070-9 / AUS; in hard case 715070-10

* SmartCure 365 nm alternatives:
EU; in cardboard box 715365-1 / EU; in hard case 715365-2
NA; in cardboard box 715365-3 / NA; in hard case 715365-4
UK; in cardboard box 715365-5 / UK; in hard case 715365-6
JP; in cardboard box 715365-7 / JP; in hard case 715365-8
AUS; in cardboard box 715365-9 / AUS; in hard case 715365-10



IRT UV SPOTCURE

450 W UV-A LED flexibility

IRT UV SpotCure is a robust, easy-to-use, UV-LED curing unit designed for many hours of high efficiency curing. High-intensity, handheld flexibility.

Low energy consumption and a long LED life time keeps the cost per curing job very low. With built-in fans, the UV-A LED's and internal components are kept cool, reducing the risk of overheating the units.

This extends the lifetime of the lamps to beyond 20,000 hours, with a minimal loss of curing power over that time.

- High intensity curing with 450 W power
- Powerful ventilation, long life, low maintenance
- Retrofit your UV SpotCure with a stand

ULTIMATE CURING GUIDE

To obtain peak performance, work at appr 100 mm from surface.
 @ filler/primer thickness 80-120 µm:
 Ø 200 mm is cured in appr 20 sec.
 (Peak light intensity >120 mW/cm², average >70 mW/m²).



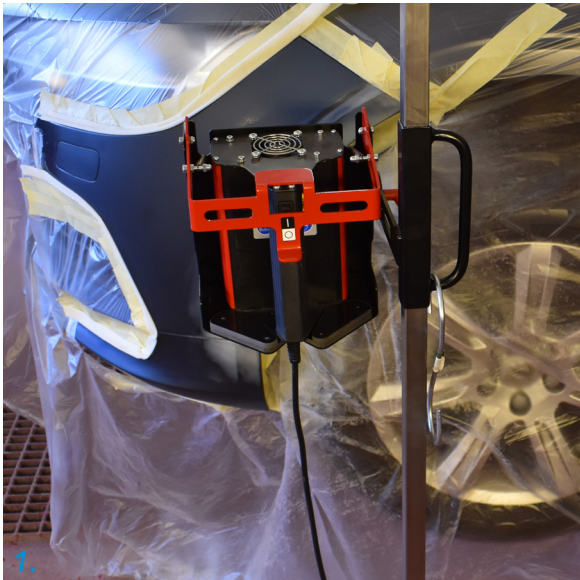

1-2. SPOTCURE ON STAND (OPTIONAL)
 Combined fixed/handheld curing.



2.

IRT UV SPOTCURE

Part no.	Current	Output power	Fuse	Voltage	Risk group EN62471	Frequency
800805 Stand						
800802 SpotCure	4.0 A	450 W	15 A	110-130V, 1 PH, NA	3 (RG-3)	50-60 Hz

UV Safety glasses included in delivery. Ambient temp max 40° C.

DIMENSIONS

Handheld (WxHxD)	6x8x6 in
Weight handheld unit	3 lb
Bracket (WxHxD)	10x15x8 in
Weight Bracket and handheld unit	15.5 lb
Stand (WxHxD)	18x57x24 in
Stand weight	28 lb
Cord length	33 ft



COMBINATION OF IR AND UV-A CURING

Our best in class IR and UV-A dryers in one

The IRT COMBI dryer is 2 in 1 - saving space in the workshop while allowing complete flexibility.

The combination of short-wave infrared and UV-A radiation makes this mobile dryer unique. One cassette includes 4 IR lamps and 1 UV-A lamp.

The UV-A lamps have an outstanding intensity to achieve the best curing result. The infrared lamps are mounted in gold coated reflectors, reflecting up to 97 % of the short-wave radiation.

The IRT COMBI features 12 IR and 3 UV-A pre-programmed programs for water and solvent based paint material, from putty to clear coat. Available as flexible mobiles and easy-gliding rail dryers.

- High-quality and durable curing
- Space saving curing solution
- Short-wave IR drying and UV-A curing

SAFE UV-A CURING

The ozone-free lamps and the protective glass filters out the UV-B and UV-C rays. If the glass breaks or is missing, the light has a safety switch preventing the lamp to ignite.

FLEXIBILITY AND EFFICIENCY

Space saving infrared and UV-A drying techniques which can be run individually and in sequence.

SAFETY FIRST

Always use UV safety glasses when handling UV-A light. We supply a pair with each delivered unit.



IRT 4-1 IR-UVA

Mobile dryer with unique combination of IR and UV-A techniques

- One cassette with 4 IR lamps and 1 UV-A lamp
- Featured with 12 IR- and 3 UV-A pre-programmed programs
- Easy to position

DIMENSIONS

Stand height	1450 mm
Cassette vertical range (height)	80-2240 mm
Width	1230 mm
Weight	70 kg
Curing area	
- IR*	1,1 x 1,5 m
- UV-A**	1,0 x 1,0 m

* Curing area at a distance of 60 cm, on black sheet metal
** At a distance of 55 cm

IRT COMBI 4-1 IR-UVA

Part no.	Power	Fuse	Current	Voltage	Frequency
800605	IR: 6 kW UVA: 1,2 kW	10 A	IR: 9 A UVA: 3 A	380-420V, 3 Ph/PE	50-60 Hz



IRT 4-2 IR-UVA

Mobile dryer with unique combination of IR and UV-A techniques

- Two cassettes, each cassette equipped with 4 IR lamps and 1 UV-A lamp
- Featured with 12 IR- and 3 UV-A pre-programmed programs
- Easy to position

DIMENSIONS

Stand height	1450 mm
Cassette vertical range (height)	80-2240 mm
Width	1230 mm
Weight	85 kg
Curing area	
- IR*	2,2 x 1,5 m
- UV-A**	1,8 x 1,0 m

* Curing area at a distance of 60 cm, on black sheet metal
** At a distance of 55 cm

IRT COMBI 4-2 IR-UVA

Part no.	Power	Fuse	Current	Voltage	Frequency
800606	IR: 12 kW UVA: 2,4 kW	16 A	IR: 16 A UVA: 6 A	380-420V, 3 Ph/PE	50-60 Hz





IRT 4-10 IR-UVA

Rail dryer with IR and UV-A radiation

- One cassette with 4 IR lamps and 1 UV-A lamp
- 12 IR- and 3 UV-A pre-programmed programs
- Unique combination of IR and UV-A curing



IRT COMBI 4-10 IR-UVA

Part no.	Power	Fuse	Current	Voltage	Frequency
800618	IR: 6 kW UVA: 1,2 kW	Max 100 A	IR: 9 A UVA: 3 A	380-420V, 3 Ph/PE	50-60 Hz

DIMENSIONS

Installation height	2250-3150 mm
Cassette vertical range (height)	80-2240 mm
Weight	70 kg
Curing area	
- IR*	1,1 x 1,5 m
- UV-A**	1,0 x 1,0 m

* Curing area at a distance of 60 cm, on black sheet metal
** At a distance of 55 cm

IRT 4-20 IR-UVA

Rail dryer with IR and UV-A radiation

- Two cassettes, each cassette equipped with 4 IR lamps and 1 UV-A lamp
- 12 IR- and 3 UV-A pre-programmed programs
- Unique combination of IR and UV-A curing



IRT COMBI 4-20 IR-UVA

Part no.	Power	Fuse	Current	Voltage	Frequency
800619	IR: 12 kW UVA: 2,4 kW	Max 100 A	IR: 16 A UVA: 6 A	380-420V, 3 Ph/PE	50-60 Hz

DIMENSIONS

Installation height	2250-3150 mm
Cassette vertical range (height)	80-2240 mm
Weight	85 kg
Curing area	
- IR*	2,2 x 1,5 m
- UV-A**	1,8 x 1,0 m

* Curing area at a distance of 60 cm, on black sheet metal
** At a distance of 55 cm



WORKSHOP CUSTOMIZATION

Please contact your local retailer or IRT sales contact for assistance with customization for your workshop.

IRT RAIL SYSTEMS

Tailor-made for prep area and spray booth

Operational safety with integrated cables

The IRT Rail System can be equipped with any number of IRT dryers, all hanging on easy-glide, self-balanced cassette arms.

With the IRT Rail System you can quickly maneuver the dryer into the perfect curing position, reaching all parts of the vehicle, without obstructing loose cables. The IRT Rail System comes in a variety of shapes and sizes and is customizable to suit any type of workshop.

OPERATIONAL SAFETY

High quality with closed rails and integrated cable system extends lifetime and creates a maintenance free environment.

LOWBUILT TO SUIT WORKSHOPS

Long experience with rail system installation has resulted in this extremely lowbuilt construction.

FOR PREP AREA & SPRAY BOOTH

Our standard sidehung cross rail system fits most workshops. Customized solutions are also available to fit all prep areas and paint booths.



SIDEHUNG CROSS RAIL SYSTEM Standard.
(Max length cross rail 7 m (22'11"))

UNDERHUNG CROSS RAIL SYSTEM



WALL RAIL SYSTEM



RAIL SYSTEM

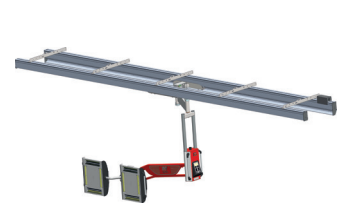



IRT RAIL DRYERS

Easy gliding and self-balancing dryers



SAFE AND CLEAN

As the electric power supply is integrated in the rails, there are no loose cables dragging along the floor disrupting work and stirring up dust.



IRT CONTROL SYSTEM

User-friendly advanced system, pre-programmed to monitor the curing process.



DUST & SURVEILLANCE SYSTEM

Optional, use in enclosed spray booth or combined spray and dry booth. Security control of unit and protection of the cassettes.

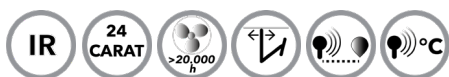

IRT 3-20

Adapted for prep station and spray booth

- Two cassettes - each cassette with 3 IR lamps
- Electronic distance sensor
- Computerized curing process



IRT 3-20 PCD

Part no.	Current	Output power	Fuse	Voltage	Frequency
800477	15 A	6 kW	16 A	200-230V, 3 PH, EU, JP	50-60 Hz
800463	9 A	6 kW	16 A	400V, 3 PH, EU	50-60 Hz

DIMENSIONS

Installation height	2250-3150 mm
Cassette vertical range (height)	140-2500 mm
Weight	60 kg
Curing area*	2,0 x 1,1 m

* Curing area at a distance of 60 cm, on black sheet metal



IRT 4-10

User friendly advanced technology

- One cassette with 4 IR lamps
- Controls the temperature with a pyrometer and laser circle
- Computerized monitoring of curing
- Electronic distance sensor

IRT 4-10 PCAUTO

Part no.	Current	Output power	Fuse	Voltage	Frequency
800489	9 A	6 kW	10 A	400V, 3 PH, EU	50-60 Hz
800525	15 A	6 kW	20 A	200-230V, 3 PH, NA ETL	50-60 Hz
800494	9 A	6 kW	15 A	440-480V, 3 PH, NA ETL	50-60 Hz

DIMENSIONS

Installation height	2250-3150 mm
Cassette vertical range (height)	140-2500 mm
Weight	50 kg
Curing area*	1,1 x 1,5 m

*)Curing area at a distance of 60 cm, on black sheet metal



IRT 4-20

User friendly advanced technology

- Two cassettes with 4 IR lamps
- Controls the temperature with a pyrometer and laser circle
- Computerized monitoring of curing
- Electronic distance sensor

IRT 4-20 PCAUTO

Part no.	Current	Output power	Fuse	Voltage	Frequency
800480	30 A	12 kW	32 A	200-230V, 3 PH, EU, JP	50-60 Hz
800498	30 A	12 kW	30 A	200-230V, 3 PH, NA ETL	50-60 Hz
800464	17 A	12 kW	20 A	400V, 3 PH, EU	50-60 Hz
800479	17 A	12 kW	20 A	440-480V, 3 PH, NA ETL	50-60 Hz

DIMENSIONS

Installation height	2250-3150 mm
Cassette vertical range (height)	140-2500 mm
Weight	60 kg
Curing area*	2,2 x 1,5 m

*)Curing area at a distance of 60 cm, on black sheet metal



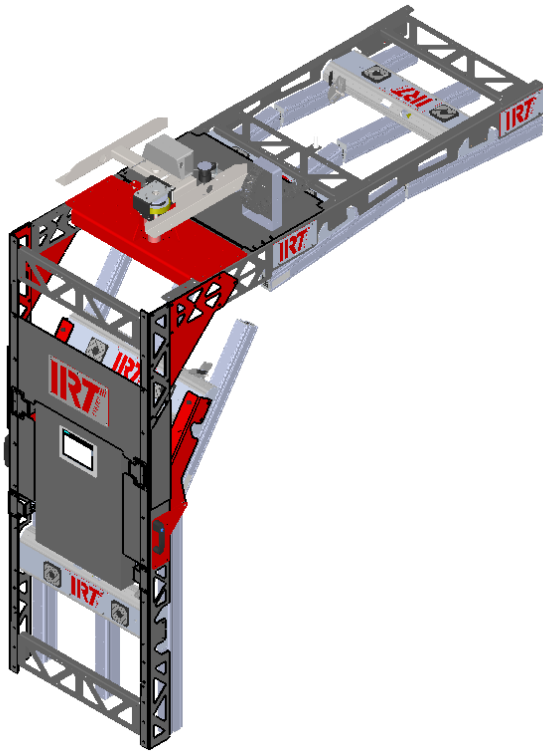

IRT FLEXICURE

Shorter curing times in the prep area

IRT FlexiCure moves over the chosen panel automatically, curing from the inside out, preventing solvent to be trapped inside the coating, ensuring fast and high quality curing.

Accelerated curing in the prep area, both automatic and manual, static and dynamic. Simply choose the desired panels to be dried and start the curing process thereby contributing to a cost-effective and environmental friendly process.

- Flexible installation in prep area with IRT Rails
- Tiltable zone for adjusted effect
- Requires very little parking space

TIME SAVING IN THE PREP AREA

IRT FlexiCure is installed in a standard IRT Rail System and accelerates curing of water- and solventbased base and clear coats.

4 CURING ZONES

Each zone is equipped with shortwave infrared lamps, gold coated reflectors and pyrometer. 3 IR lamps/zone with a total power of 38 kW.

COST EFFECTIVE PROCESS

IRT FlexiCure saves energy by only activating the necessary IR lamps using pyrometers and distance sensors.

WORKSHOP CUSTOMIZATION

Please contact your local retailer or IRT sales contact for assistance with customization for your workshop.

TECHNICAL DATA

Rated voltage	Nominal frequency	Full load current	Main disconnect fuse	Sound pressure level	Sound power level	Curing temp. (curing surface)	Ambient temp. (during operation)	Weight FlexiCure excluding rails
400-480 V ~3Ph/PE ± 5%	50-60 Hz	55 A	65 A	≤ 70 dB (A) at 1 m	≤ 70 dB (A) at 1 m	Max. 170°C	Max. 40°C	150 kg



IRT POWERCURE

Shorter curing times in the spray booth

IRT PowerCure drastically shortens curing times for all paint materials with a minimum of energy used.

IRT PowerCure turns your traditional booth into a rapid curing booth. The vehicle is ready to move forward in minutes. Selection of panels and paint type is done quickly and easily on the touch control panel. The vehicle and loose parts can be cured in the same drying cycle.

IRT PowerCure can be installed in new spray booths as well as be retrofitted in existing spray booths. Calculate 1,2 m for IRT PowerCure and another minimum 8 meters to pass over the vehicle and angle front/back.

- Easy to retrofit in spray booth (min 9,2 m)
- Reaches front/back of vehicle with angling wings
- Adapts to paint material, size and shape of vehicle
- A typical coating is cured in 10 minutes or less

WORKSHOP CUSTOMIZATION

Please contact your local retailer or IRT sales contact for assistance with customization for your workshop.

TECHNICAL DATA

Frequency	Installed Power	Voltage	Part no.
50-60 Hz	54 kW / 63 A (20 lamps à 3 kW less 6 kW supply voltage compensation)	400 V, 3Ph ~/PE	800410* IRT PowerCure Single 800490* IRT PowerCure Double

*) Incl. Surveillance System

EVEN HEAT DISTRIBUTION

The front and back of the vehicle are easily cured with the wing angled towards the painted surface. The shape and positioning of the reflectors give an even heat distribution.

LESS ENERGY CONSUMPTION

IRT PowerCure detects the starting position and saves energy by only activating the necessary IR lamps. Simply choose the desired panels to be dried and start the curing process.

ENERGY CONSUMPTION

Typical energy consumption, clear coat on base coat, medium sized vehicle, medium colour shade:

Front wing	6 min	0,95 kWh
Door	5 min	0,95 kWh
Front wing + door	10 min	1,6 kWh
Hood	7 min	1,5 kWh
Hood + 2 wings	9 min	2,8 kWh
Complete car	26 min	15,8 kWh



IRT IR DRYERS

Basic features

	IRT 1 Prep- Cure	IRT 2 Prep- Cure	IRT 3 Prep- Cure	IRT 4 Prep- Cure	IRT 3-1 PcD	IRT 3-2 PcD	IRT 4-1 PcAuto	IRT 4-2 PcAuto
Even heat distribution	•	•	•	•	•	•	•	•
Short curing times	•	•	•	•	•	•	•	•
Environmentally friendly, efficient use of energy	•	•	•	•	•	•	•	•
24 carat gold coated reflectors with 97% reflection	•	•	•	•	•	•	•	•
Powerful ventilation provides the lamps with a service life of up to 20,000 operating hours		•	•	•	•	•	•	•
FreeForm reflectors for an unsurpassed drying surface		•	•	•	•	•	•	•
Efficient particle filter that creates a dust-free environment in the cassettes			•	•	•	•	•	•
Enclosed cassette cables			•	•	•	•	•	•
The angle of the arm provides increased reach				•	•	•	•	•
The stand is adapted also to dry high cars, e.g. SUVs				•	•	•	•	•
The arm is self-locking in all positions				•	•	•	•	•
Electronic distance sensor					•	•	•	•
Self-instructive programs					•	•	•	•
Computerized curing process					•	•	•	•
12 program pre-sets - 3 custom programs					•	•	•	•
Programs for plastic/metal/water/solvent					•	•	•	•
18 languages					•	•	•	•
Pyrometer for exact temperature control							•	•
Clear display with graphics showing the exact progress of the curing process							•	•
Computerized temperature monitoring of curing process							•	•
Laser circle indicates where temperature measurement takes place							•	•



IRT UV-A DRYERS

Basic features

	UVA 1-3	UVA 1-4	UVA 2-4	IR/ UVA 4-1	IR/ UVA 4-2	SpotCure	SmartCure
Environmentally friendly, efficient use of energy	•	•	•	•	•	•	•
Premium product with long lifetime >5 years	•	•	•	•	•	•	•
Powerful ventilation provides the lamps with a service life of up to 20,000 operating hours				• (IR)	• (IR)	•	•
Low maintenance	•	•	•	•	•	•	•
UV-LED*						•	•
Handheld unit						•	•
Battery operated							•
UV-A wavelength 395 nm						•	•
UV-A wavelength 365 nm						•**	•
High efficiency UV-A pressure lamp	•	•	•	•	•		
UV-A wavelengths 315-395 nm	•	•	•	•	•		
Cures water/solvent based products				•	•		
Programs for plastic/metal/water/solvent				•	•		
Computerized curing process				•	•		

* The range of paint absorption must match the wavelength of irradiated light.

** UV-LED for 365 nm available shortly.

SPARE PARTS

IRT UVA SpotCure	Art. no.
UV/IR Protective glasses	129070
Stand for SpotCure	800805
Timer for SpotCure stand (not for 800802, NA)	712821

IRT UVA SmartCure	Art. no.
UV/IR Protective glasses	129070
Battery 18V Li-ion	715093
Battery charger 18V	715094
Filter	715074
Dust cover	715193
Hard case	800806
Cable for charger (EU plug)	715154
Wall bracket	715129

IRT COMBI IR-UVA	Art. no.
UV/IR Protective glasses	129070
UV lamp replacement kit 400V 1,2 kW	714842
Lamp IR 2 kW 235V 360 U CPL	102699
Lamp IR 1 kW 235V 360 U CPL	102700
Filter cassette assembly w. nylon plugs	713576

IRT UVA X PrepCure X	Art. no.
UV/IR Protective glasses	129070
Air filter	712894
UV lamp replacement kit 230V 1 kW	714599

IRT 1 & 2 PrepCure	Art. no.
IR Lamp 360, 1kW, 230V	102700
Lamp holder LRU3 (M5x16) w. washer	712393
Knob (wing) male M8, for stand	410009
Timer EU 1 PH + PE, for stand	180508

IRT 3 & 4 PrepCure	Art. no.
IR Lamp 360, 1kW, 230V	102700
Lamp holder LRU3 (M5x16) w. washer	712393
Fan 12V DC 92x92 mm	711186
Filter cassette assembly w. nylon plugs	713576
Gas spring 800 N - IRT4 PrepCure	713776
Main switch	420771
Keyboard PrepCure	750496
PCB (Printed Circuit Board) PrepCure	750481
Wheel kit, h=100mm, w=32mm	412364
Solid state relay cpl	126313
Adj bolt with with Nut M12*1,5	120295

IRT 3-X PcD	Art. no.
IR Lamp 360, 1kW, 230V	102700
Lamp holder LRU3 (M5x16) w. washer	712393
Fan Hyperion 12V, w. mesh and plug	714011
Filter cassette assembly w. nylon plugs	713576
Gas spring 850 N - PcD (one cassette)	714060
Gas spring 1400 N (two cassettes)	713614
Solid state relay	750227
Wheel kit, h=134mm, w=32mm	410523
Transformer 230/400/480VAC/12VDC	750630
Display 128x64 points w. lightning	750220
Overlay/keyboard IRT 8 keys	750366
Distance sensor kit 3-1, 3-10 PcD	713737
Distance sensor kit 3-2, 3-20 PcD	713957
PCB (Printed Circuit Board) IRT 3-1 PcD	714012
PCB (Printed Circuit Board) IRT 3-2 PcD	714013

IRT 4-X PcAuto	Art. no.
IR Lamp 360, 1kW, 230V	102700
IR Lamp 360, 2kW, 230V	102699
Lamp holder LRU3 (M5x16) w. washer	712393
Fan Hyperion 12V, w. mesh and plug	714011
Filter cassette assembly w. nylon plugs	713576
Gas spring 850 N (one cassette)	711464
Gas spring 1400 N (two cassettes)	713614
Solid state relay	750227
Wheel kit, h=134mm, w=32mm	410523
Transformer 230/400/480VAC/12VDC	750630
Display 128x64 points w. lightning	750220
Overlay/keyboard IRT 8 keys	750366
Pyrometerkit 4-1 PcAuto	713637
Pyrometerkit 4-2 PcAuto	713864
PCB (Printed Circuit Board) IRT 4-1 PcAuto	714014
PCB (Printed Circuit Board) IRT 4-2 PcAuto	714015



WE ARE HERE FOR YOU!

Sales - USA & Canada

Mike Bertrand
Shelley Featherstone
Colin Hammacott

mike.bertrand@hedson.com
shelley.featherstone@hedson.com
colin.hammacott@hedson.com

Customer Service

Orders
General inquiries
Technical support
Orders (DE)
General inquiries (DE)
Technical support (DE)

order.a@hedson.com
info@hedson.com
support@hedson.com
bestellung@hedson.com
info.de@hedson.com
service.de@hedson.com

Sales - Germany, Austria, Switzerland and the Netherlands

Jos Keijenberg, Sales leader & NL
Alex Kohl, West
Michael Eismann, Northeast
Hans-Joachim Draband, North
Hans-Juergen Dollmann, DE Southwest & CH
Sven Janssen, Southeast & AT

jos.keijenberg@hedson.com
alex.kohl@hedson.com
michael.eismann@hedson.com
hans-joachim.draband@hedson.com
hans-juergen.dollmann@hedson.com
sven.janssen@hedson.com

Sales - France

Cedric Desmettre
Daniel Jorge

cedric.desmettre@hedson.com
daniel.jorge@hedson.com

Sales

Niklas Johansson, Sales Leader
Eva Löfgren, Nordics
Magnus Lojander, Nordics & UK
Janusz Deneka, Eastern Europe
Carlos Herrera, Spain & Portugal
Juan Alloza, China, South America, Korea
Gulsha Råjavan, APAC, Baltics & Balkan

niklas.johansson@hedson.com
eva.lofgren@hedson.com
magnus.lojander@hedson.com
janusz.deneka@hedson.com
carlos.herrera@hedson.com
juan.alloza@hedson.com
gulsha.rajavan@hedson.com