

Assembly instructions for spray gun cleaner **DRESTER 8000GC**

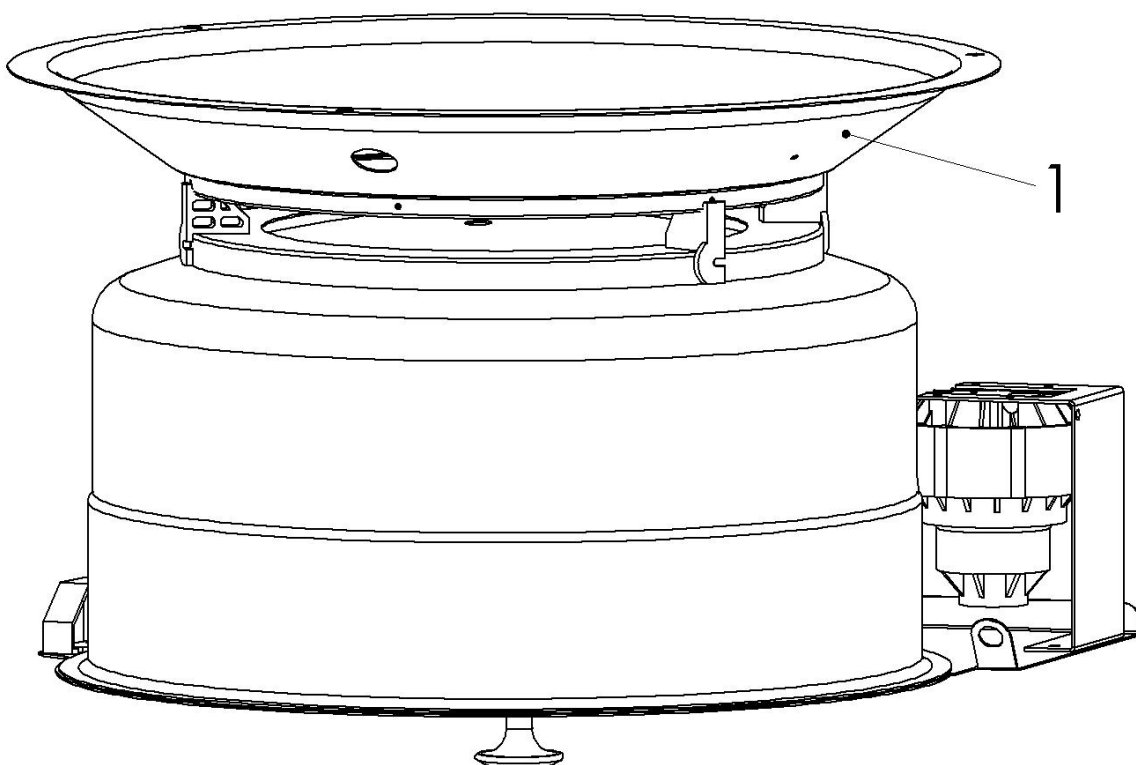

The DRESTER 8000GC is delivered collapsed in a box. To assemble it, you need a Phillips screwdriver and 16 screws. The screws are to be found in a plastic bag taped to the side of the unit. Follow the instructions below.

1. Take the sheet-metal stand, the extractor tube, the spillage collection tray and the sticker plate out of the box.
2. Take the gun cleaner out of the box and put it on the floor, upside-down (*see picture 1*).
3. Remove the 4 screws (*see picture 2*) holding the circular foot plate (*see picture 1, item 1*). Remove the foot plate and put it next to the unit, on the floor. Remove the 4 plastic spacers from the foot plate (*see picture 3*). These are shipping items only and can be disposed of.
4. Bend the sheet-metal stand to a circular shape (*see picture 4*).
5. Mount said stand on the rim on the sink's underside, using 5 screws (*see picture 5, item 1*). Note that the black 1/2" grooved hose, the 1/2" semi-transparent hose, the 1/4" transparent hose and one of the ground cables, shall pass through one of the slots in the stand (*see picture 5, item 3*). The second 1/2" semi-transparent hose passes through the other slot in the stand. The white 1/2" grooved shall be left outside the stand (*see picture 5, item 4*).
6. Fit the drain hose onto the drain nipple (*see picture 5, item 2*). Be sure to press it all the way down to the hexagon flange.
7. Mount the foot plate to the sheet-metal stand, using 5 screws (*see picture 6*).
8. Turn the unit upright.
9. Fit the extractor tube, using 3 screws, to the plastic flange (*see picture 7*). Make sure that the red dot on the extractor tube faces backwards.
10. Fit the extractor's 5/16" blue hose and the 1/2" white hose (*see picture 8*).
11. Lead the level sensor hose through the slot in the stand (*see picture 9*).
12. Fit the sticker plate on the extractor tube, using 3 screws (*see picture 10*).
13. Remove the tape holding the lid, and open the lid. Inside are part bags. These items and the spillage collection tray will be needed later when installing and using the unit according to the "General Instructions and User's Manual for spray gun cleaner DRESTER 8000GC" (document no. 13551).



Picture 1

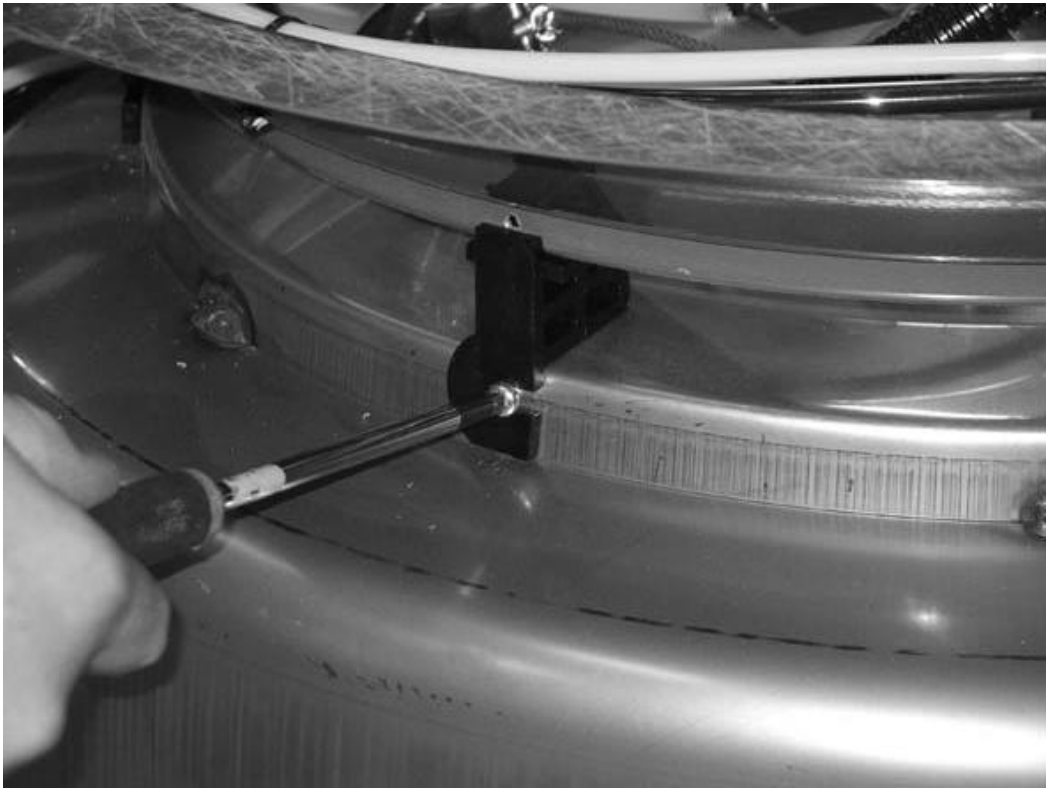

Picture 2

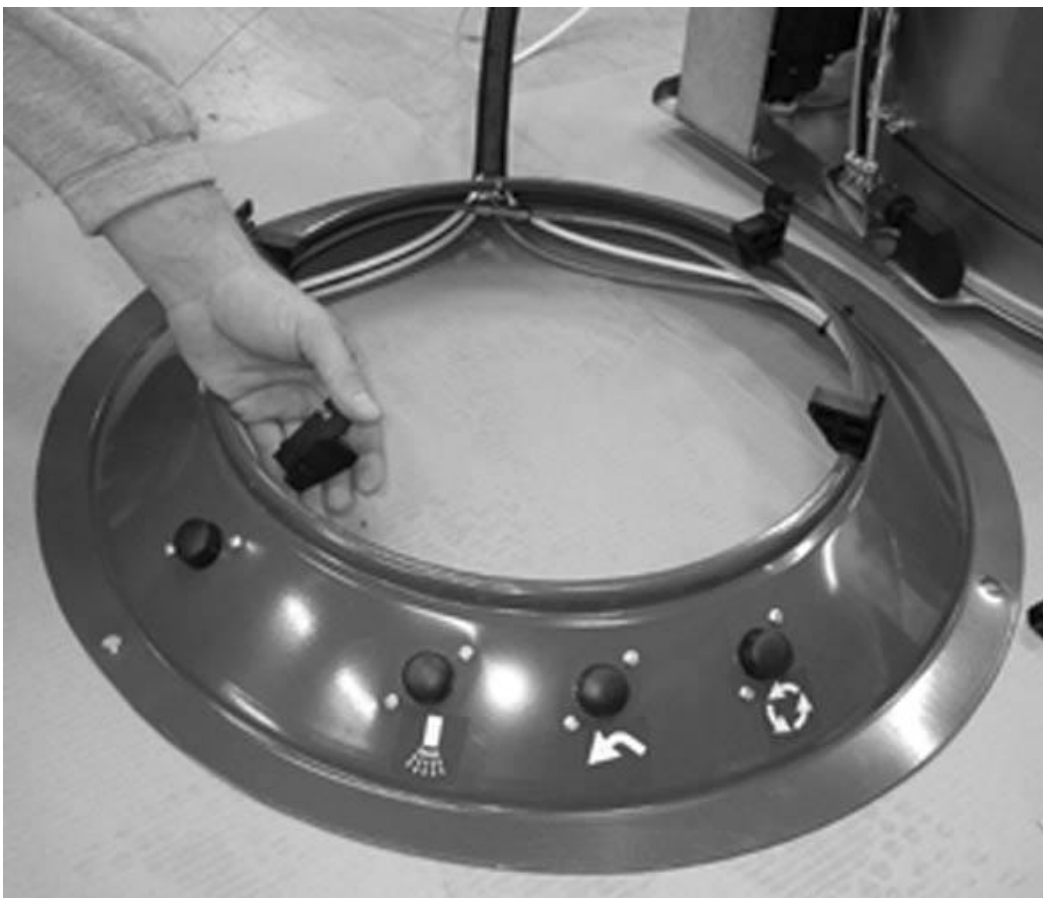

Picture 3

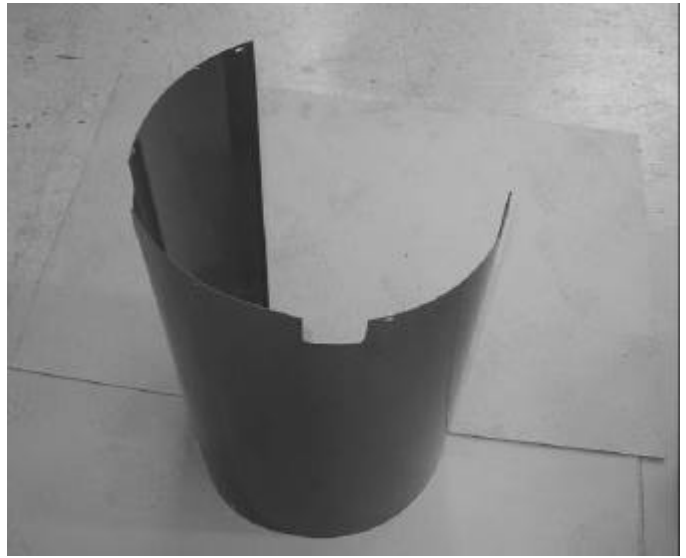
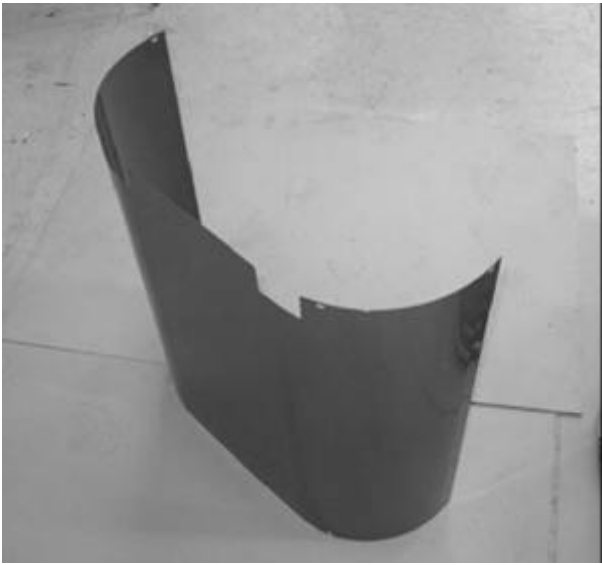

Picture4

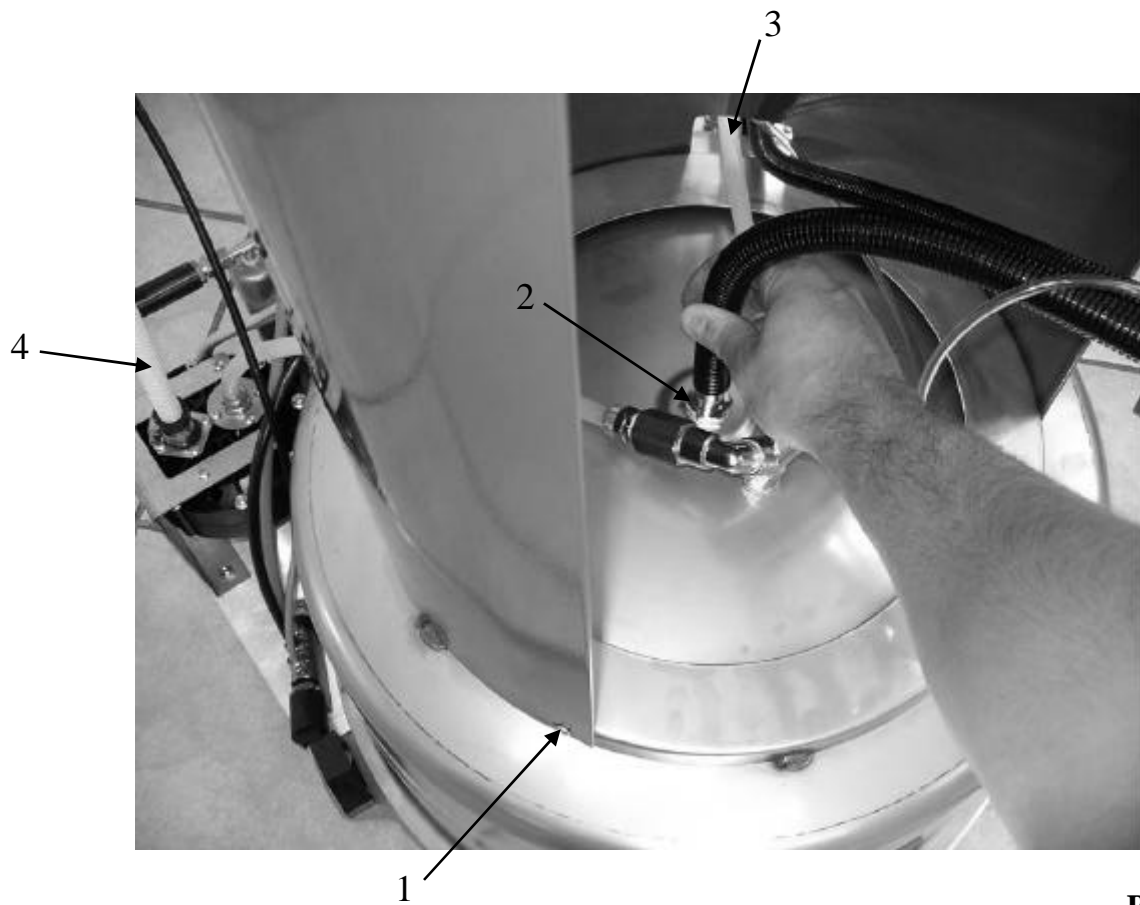

Picture 5



Picture 6

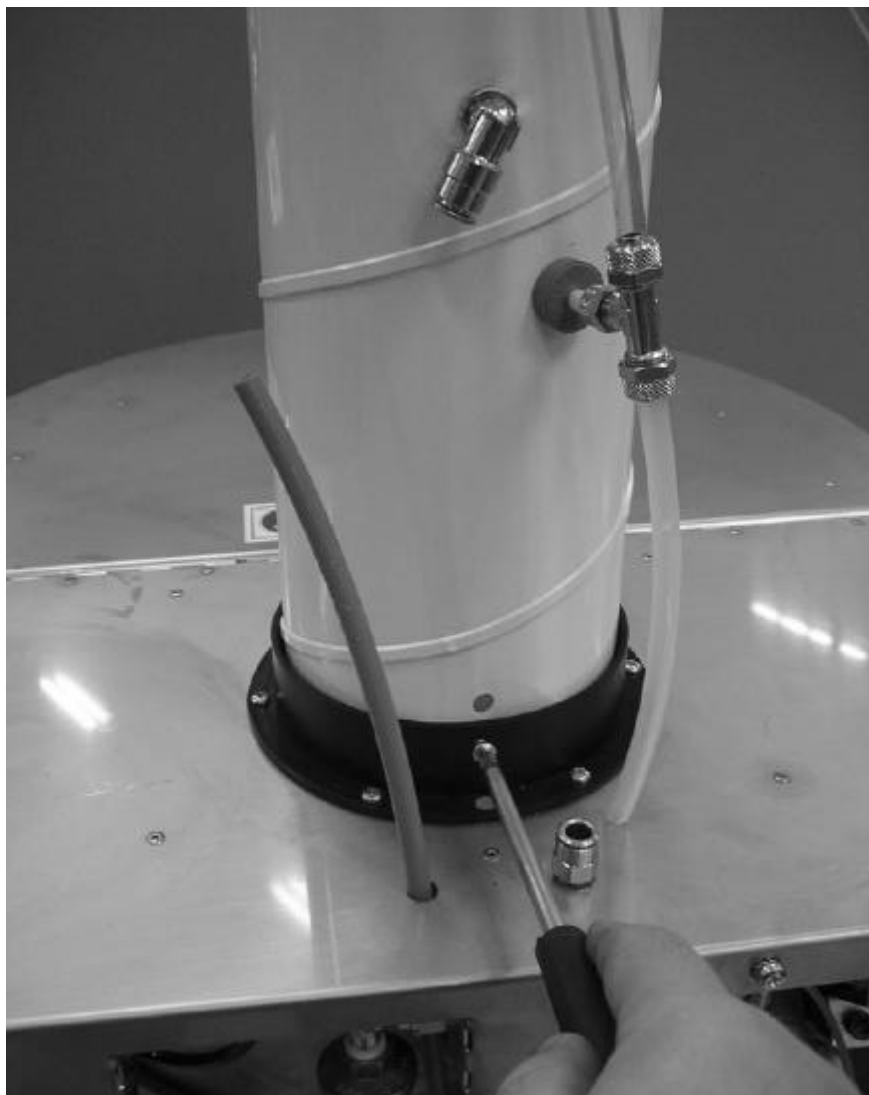

Picture 7



Picture 8



Picture 9



Picture 10



The DRESTER 8000GC is now assembled. Read the *Instructions and User's Manual for spray gun cleaner DRESTER 8000GC* for further information.