



HEDSON PRODUCT CATALOGUE



 **HEDSON**

— PERFORMANCE ABOVE ALL —

HEDSON TECHNOLOGIES

Hedson Technologies has a history from late 1960^s, when we were the first to invent the infrared dryers with short-wave IR and in the 1970^s we developed spray gun cleaners and pneumatic lifts. Ever since then we have been market leader in the automotive refinishing industry.

With user experiences, innovative technology and well-planned concepts, all Hedson products have one thing in common, to deliver products that meet the high demands of professional customers.

Hedson's products also stand for safety and environmental considerations. They therefore meet international demands and standards in accordance with the Quality Standard ISO-9001 and ISO-14001.

In 2014 Hedson Technologies was acquired by Mellby Gård Innovation och Tillväxt AB, a solid well-known and privately owned Swedish industry investor.

Hedson has a global presence in nearly 80 countries, with offices in Sweden, Germany, France and North America.

TIME IS MONEY, and this is as important on the shop floor as anywhere else.

That is why Hedson brands such as Drester, Herkules and IRT are engineered with one thing in mind - to help you serve customers faster, better and more profitably.

That means advanced equipment that is fast, effective and easy to use. Equipment that doesn't go down when you need it the most. Because of the full Hedson range available from a single source, you'll save time and money.

WHEN YOU'RE GOING TO EQUIP, EQUIP TO WIN.

WITH HEDSON SOLUTIONS YOU

- **SAVE** energy dollars
- **INCREASE** throughput
- **REDUCE** cycle times
- **INCREASE** revenue
- **MAXIMIZE** profitability
- **IMPROVE** quality



Head office in Arlöv, Sweden



CURING

IRT Infrared and UV curing, Rail System and PowerCure for the workshop.

06

<i>IRT PrepCure.....</i>	<i>8</i>	<i>IRT UVA PrepCure 4.....</i>	<i>16</i>
<i>IRT PcAuto.....</i>	<i>10</i>	<i>IRT Combi IR-UVA.....</i>	<i>17</i>
<i>IRT PcD.....</i>	<i>12</i>	<i>IRT Rail Systems.....</i>	<i>18</i>
<i>IRT UVA 1 PrepCure 3.....</i>	<i>15</i>	<i>IRT PowerCure.....</i>	<i>24</i>



CLEANING

Drester spray gun cleaners and equipment for the mixing room.

28

<i>Drester Boxer.....</i>	<i>29</i>	<i>Drester Mixing Table.....</i>	<i>39</i>
<i>Drester Classics.....</i>	<i>34</i>	<i>Drester Dynamic Triple.....</i>	<i>40</i>
<i>Drester X-Series.....</i>	<i>37</i>	<i>Drester Waste Management.....</i>	<i>41</i>
<i>Drester QuickRinse.....</i>	<i>38</i>	<i>Drester Consumables.....</i>	<i>42</i>
<i>Drester GC Equipments.....</i>	<i>39</i>		



LIFTING/DUST EXTRACTION

Herkules lifts, dust extractions and lifting equipment's for the body and paint shop.

45

<i>Herkules HLS 1200.....</i>	<i>46</i>	<i>Herkules HM 1100.....</i>	<i>53</i>
<i>Herkules HLS 1600.....</i>	<i>47</i>	<i>Herkules Transmobile.....</i>	<i>54</i>
<i>Herkules HLS 3200.....</i>	<i>48</i>	<i>Herkules Painter.....</i>	<i>57</i>
<i>Herkules 1200 DUO.....</i>	<i>50</i>	<i>Herkules Dust Extraction.....</i>	<i>58</i>
<i>Herkules 3200 DUO.....</i>	<i>51</i>	<i>Herkules Accessories.....</i>	<i>62</i>
<i>Herkules HLQ.....</i>	<i>52</i>		



CLEANING

Drester wheel washers for the tire shop.

64

<i>Drester GP24.....</i>	<i>66</i>	<i>Drester W-450.....</i>	<i>69</i>
<i>Drester GP12 / GP10.....</i>	<i>67</i>	<i>Consumables/Accessories.....</i>	<i>70</i>

HEDSON BODY SHOP SOLUTIONS

Serve customers faster, better and more profitably

High profitability in a car refinishing paint shop is obtained by processing repair jobs in the most efficient way. Bottlenecks and waiting times must be minimized so the car can be returned to its owner in the shortest possible time. The objective for all Hedson solutions is to offer high productivity and performance as well as saving time and energy.

To provide maximum productivity in the body shop, the best possible use of floor space must be under consideration, but also considering health and safety regulations.

CURING

High performance workshop equipment that saves time and money

Careful consideration of body shop heating requirements will not only result in energy consumption savings but also make the body shop more comfortable. IRT by Hedson curing products ensures that they don't take up unnecessary floor space and due to the freeform reflectors heat consumption are reduced to a minimum. Ceiling-mounted dryers are ideal for body shop use, since they do not take up usable space and encroach into the working area.

- Drying technology that speed up the workflow
- Advanced curing technology that is easy to use
- Reduces the energy consumption

LIFTING EQUIPMENT

Innovations to serve customers faster, better and more profitably

The quality of preparation fixes the final finished paint level in the preparation area.

Polluted air is often invisible to the naked eye. The effect it can have on the health of a workforce and the overall efficiency can be dramatic. The Herkules by Hedson lifts are silicone free and with use of Herkules by Hedson dust extraction it is an effective way to capture airborne pollutants at the source from fillers and paint dust from rubbing down and flattening processes etc.

- Comfortable and ergonomic working height with pneumatic lifts
- Efficient dust extraction to keep the workshop clean
- Flexible solutions that speed up the workflow



CLEANING

Reliable and environmentally friendly solutions with high quality

The mixing room provide a clean environment and is the workspace utilized to mix and prepare paint for the vehicles that must be painted. These rooms are often small and the Drester by Hedson gun cleaners and additional equipment are ideal for space constrained mixing rooms.

Drester by Hedson offer several standard gun cleaners that are easy to use, fast and gives a superior cleaning result, all to meet the needs that are specific to different sizes of body shops. All additional equipment's such as mixing tables, waste collectors, recyclers etc. are provided by Drester to make the mixing room as optimized as possible.

- Excellent cleaning performance
- Minimizes the exposure of chemicals
- Flexible solutions for every size and need

PAINT BOOTH

Efficient solutions that improves the workflow

The purpose of a paint booth is to control the environmental conditions while an object is being spray-painted. IRT by Hedson offers fixed curing installations for the paint booth. With these products, the energy consumption is reduced, heating and curing only occurs on the selected panels instead of the entire vehicle and paint booth.

To move the vehicle easily into the paint booth, Herkules by Hedson offers several solutions, such as mobile lifts with remote control or trolleys for side transportation.

- Flexibility that saves energy, time and space
- Solutions that reduces vehicle transportation times
- Silicone free equipment makes sure the environment is clean



INFRARED & UV CURING BY HEDSON

Advanced and user friendly technology

IRT by Hedson offers a wide selection of Short-wave Infrared (IR) and ultraviolet (UVA) mobile dryers and each model has its own area of use. IRT products are user-friendly and are easy to move around in the workshop.

Every part in a IRT by Hedson dryer is based on a well thought-out and tested design based on user-friendliness and capacity.

The smart foot design even allows it to get under low cars and it is possible to place the mobile dryer around a wheel.

Another example of the well-thought-out design is the stand arm on the large models. It has acquired the characteristic IRT by Hedson angle for the cassettes to reach above the roof of high vehicles or an SUV and still stand steady and stable on the floor.

- Short curing times
- Large curing area
- Even heat distribution
- Gold-coated FreeForm reflectors
- Reduced energy consumption
- Environmentally friendly

Moving an IRT mobile around the workshop is easy thanks to its low center of gravity. It is easy to aim the cassettes at the surface to be cured because the arm is well-levelled and balanced.

THE MARKET'S MOST EFFECTIVE REFLECTORS

We are the only company having gold-coated reflectors behind the short-wave lamps. For this reason, our IR dryers have unsurpassed drying capacity.

The Hyperion FreeForm reflectors provide a superior heat distribution and a larger curing area than conventional reflectors, this aids in reduced power consumption. In turn, this increases productivity and raises the quality of the result of drying.

ENVIRONMENTALLY FRIENDLY

Our mobile dryers irradiate the object and do not heat the surrounding air thereby minimizing energy losses. This provides an efficient use of energy and shortens drying times, which is good for the environment.

TIME TO CURE PAINT

With 12 pre-set and 3 custom programs, you can handle all paint materials on the market. Thanks to the easy to read and self-guided menus, program selection is quick and easy. If you want, you can go one step further and create your own program settings. You will continuously be able to follow the curing process on the control unit display.

START THE CONTROL UNIT, SELECT A PROGRAM - THEN DRY

This is as difficult as it gets with advanced and user friendly technology.

EFFICIENT CURING TECHNOLOGY

Cures the paint from inside and out

All IRT dryers use short-wave technology. This, together with the unique IRT FreeForm reflectors, provides the best heat transfer possible.

Short-wave IR has several other advantages. It is easy to control, provides full heat immediately and penetrates deep into the paint. The paint cures from the inside and out without retaining solvents and moisture that gives rise to problems with quality. Heat losses to the air are minimal and all energy is transferred to the surface to be dried.

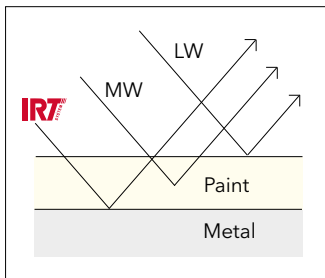

Simplified diagram

Short-wave heat cures from the inside and out, while medium-wave, long-wave and hot air primarily cure the surface.

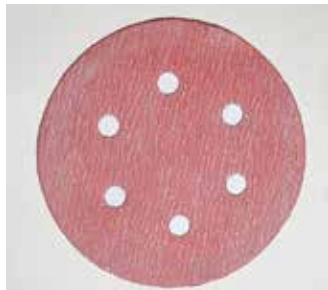

After only 3 minutes' curing you can polish with perfect results.



Despite a longer curing time with other products, only the surface is cured and the sanding paper becomes clogged.

CURING TIMES	
Putty	5-6 min
Filler, bright	10-15 min
Filler, dark	10-15 min
Water-based paint	4-6 min
Base coat	4-8 min
Top coat	10-15 min
Clear coat	10-15 min
Plastic filler	10-15 min
Plastic top coat	13-17 min
Plastic clear coat	13-17 min
Final boost	2-4 min
Soft cure	13-17 min

The curing times are extremely short. The times above apply to the IRT PcAuto series. Add a minute or two for other models.



DRYER FOR MINOR PAINT AND PANEL WORK

Dryer with simple design and function but still the same high quality as the advanced IRT dryers by Hedson

These dryers are suitable for minor paint and panel work, as well as for applying and removing stickers. Both dryers can either be used as hand-held dryers or can be mounted on stands.

When used as a hand-held dryer, areas that are difficult to reach are easy to cure. The stand has a timer that can be set to a maximum of 120 minutes. A holder on the stand allows for both vertical and horizontal drying.

All dryers from IRT by Hedson have unsurpassed drying capacity. The gold-coated reflectors provide superior heat distribution and a larger curing area than conventional reflectors, while they feature reduced power consumption. In turn, this increases productivity and raises the quality of the result of drying.

- Can cure all base coat and paint materials
- Powerful ventilation
- On/Off button integrated in handle and manual timer on the stand

TECHNICAL DATA IRT 1 PREPCURE (HANDHELD)	
Frequency	50-60 Hz
Current	4A
Output power	1 kW (one lamp)
Fuse	10 A
Stand height	1450 mm
Part.no.	Voltage
800429	230V, 1PH, EU
800624	230V, 1PH, UK (UK plug)
800431	230V, 1PH, AUS & ARG type I
800432	100V, 1PH, JP
800428	110V, 1PH, NA (not ETL)
800524	110V, 1PH, NA ETL (fixed on stand - no timer)

TECHNICAL DATA IRT 2 PREPCURE (HANDHELD)	
Frequency	50-60 Hz
Current	8A
Output power	2 kW (two lamps)
Fuse	10 A
Stand height	1450 mm
Part.no.	Voltage
800433	230V, 1PH, EU
800625	230V, 1PH, UK (UK plug)
800472	230V, 1PH, AUS & ARG type I
800434	230V, 1PH, NA ETL (fixed on stand - no timer)

STAND FOR IRT 1 & IRT 2 PREPCURE		
Part.no.	Voltage	Description
800460	230V, 1PH, EU	Stand with timer
800598	-	Stand without timer

CONSUMABLES	
Part.no.	Description
102700	LAMP-IR 1KW 235V 360 U CPL



IRT 1 PrepCure

IRT 2 PrepCure

IDEAL FOR USE IN THE PREPARATION AREA

Even the smallest models are very efficient and perfect for curing on small to medium-sized surfaces

Speed up the drying process of putty, filler and clear coat with the IRT 3 and 4 PrepCure by Hedson. With two digital timers, the dryer is very easy to use.

These dryers are equipped with a compact cassette that is controlled by two digital timers - Flash off up to 30 minutes, Full bake up to 30 minutes.

The cassette is balanced with a gas filled damper and can easily be operated with one hand. With IRT 4 PrepCure, you can reach a height of 2,150 mm, enabling curing of car roofs on high cars.

Both dryers are adjustable in a vertically position.

- Two digital timers:
 - Flash-off, 50 % output power
 - Full bake, 100 % output power
- The timer's settings will remain after power off
- Can cure all paint materials

CURING BODY SHOP SOLUTIONS

TECHNICAL DATA IRT 3 PREPCURE	
Frequency	50-60 Hz
Current	13 A
Output power	3 kW
Fuse	16 A (UK 13 A, NA 20 A)
Max. cassette height	1300 mm
Part.no.	Voltage
800610	230V, 1PH, EU
800473	230V, 1PH, UK (UK plug)
800616	230V, 1PH, AUS & ARG type I
800612	230V, 1PH, NA ETL

TECHNICAL DATA IRT 4 PREPCURE	
Frequency	50-60 Hz
Current	13 A
Output power	3 kW
Fuse	16 A (UK 13 A, NA 20 A)
Max. cassette height	2150 mm
Part.no.	Voltage
800611	230V, 1PH, EU
800443	230V, 1PH, UK (UK plug)
800617	230V, 1PH, AUS & ARG type I
800615	230V, 1PH, NA ETL

CONSUMABLES	
Part.no.	Description
102700	Lamp-IR 1kW 235V 360 U CPL
713576	IRT cassette air filter
713576-10	10 pcs IRT cassette air filter

CURING AREAS

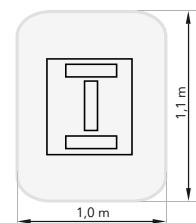

IRT 3 & 4 PREPCURE
At a distance of 600 mm, on black sheet metal



REDUCED CURING TIME

Infrared dryer equipped with user friendly advanced technology for better and faster curing

These are our most complete mobile dryers with the highest output and capacity. The products are easy to use and the curing times are reduced to a minimum.

The IRT PcAuto models are equipped with advanced technology such as a temperature measurement, laser circle and digital distance sensor. 18 different languages can easily be set.

The laser circle shows where the measurement of the temperature on the curing area takes place, and the ultrasound sensor measures the distance and signals when the distance is correct.

The temperature is continuously measured, while the microprocessor regulates the effective output

upwards or downwards in a split second for optimal curing results.

As an operator, you can continuously monitor the curing process and receive information about such things as object temperature and elapsed/remaining program time.

- Pyrometer for exact temperature control
- Computerized curing process, 12 pre-set and 3 custom programs
- Computerized monitoring of curing
- Laser circle indicates where temperature measuring takes place
- Electronic distance sensor

CURING AREAS

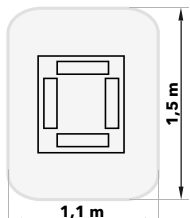

IRT 4-1 PCAUTO
One cassette at a distance of 600 mm, on black sheet metal

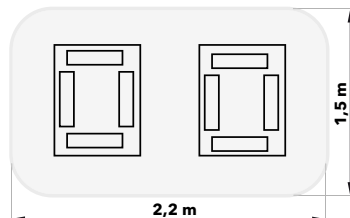

IRT 4-2 PCAUTO
Two cassettes at a distance of 600 mm, on black sheet metal

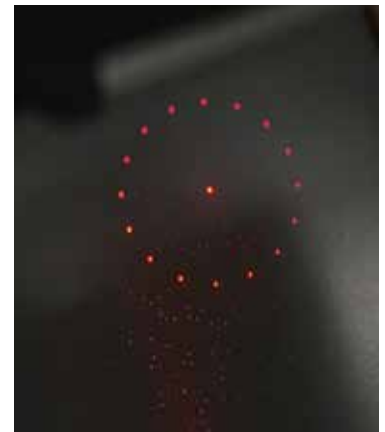

Built-in laser circle and distance sensor facilitates the settings.



IRT 4-1 PcAuto



IRT 4-2 PcAuto

TECHNICAL DATA IRT 4-1 PCAUTO		
Frequency	50-60 Hz	
Output power	6 kW	
Max. cassette height	2250 mm (h) 2550 mm (v)	
Part.no.	Voltage	Current
800423	400V, 3 PH, 4pin, EU	9 A
800425	400V, 3 PH, 5pin, EU	9 A
800421	230V, 3 PH, EU	15 A
800426	400V, 3 PH, AUS	9 A
800485	200V, 3 PH, 4P, JP	15 A
800422	230V, 1 PH, NA ETL	26 A
800468	230V, 3 PH, NA ETL	15 A
800427	440-480V, 3 PH, NA ETL	9 A
800613	440-480V, 2 PH, NA ETL	13 A

TECHNICAL DATA IRT 4-2 PCAUTO		
Frequency	50-60 Hz	
Output power	12 kW	
Max. cassette height	2250 mm (h) 2550 mm (v)	
Part.no.	Voltage	Current
800418	400V, 3 PH, 4pin, EU	16 A
800400	400V, 3 PH, 5pin, EU	16 A
800413	230V, 3 PH, EU	27 A
800415	200V, 3 PH, 4P, JP	27 A
800417	400V, 3PH, AUS	16 A
800411	230V, 1 PH, NA ETL	48 A
800414	230V, 3 PH, NA ETL	27 A
800419	440-480V, 3 PH, NA ETL	16 A
800614	440-480V, 2 PH, NA ETL	26 A

OPTION - IRT DATA COLLECTOR	
Part.no.	Description
750583	USB Cable Data Collector
750584	USB Memory Data Collector
750585	Wireless Data Collector

CONSUMABLES	
Part.no.	Description
102699	Lamp-IR 2kW 235V 360 U CPL
102700	Lamp-IR 1kW 235V 360 U CPL
713576	IRT cassette air filter
713576-10	10 pcs IRT cassette air filter

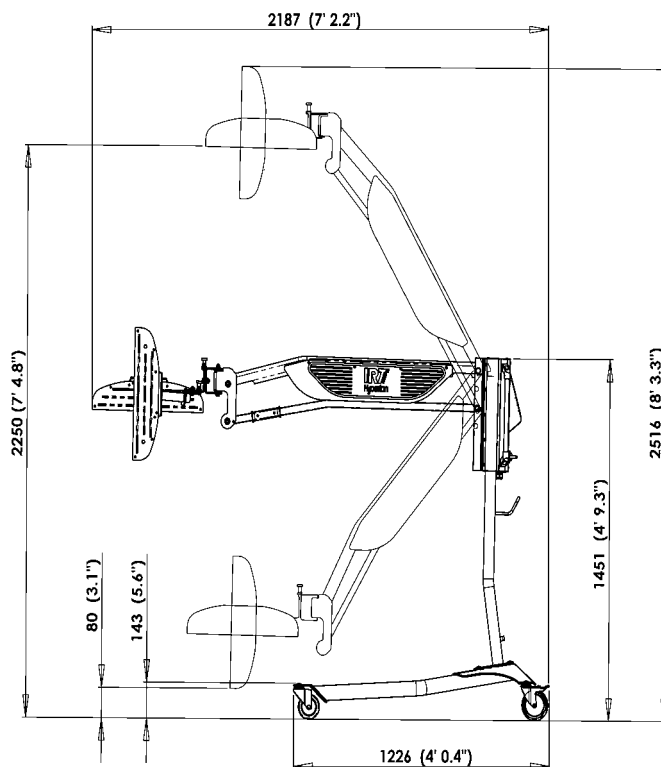

IRT 4-1, 4-2 PcAuto & IRT 3-1, 3-2 PcD

EFFICIENT AND QUICK CURING

Standard dryer with process control for all types of workshops and paint materials

These are the standard dryers for all types of workshops. They are mostly used for small to medium-sized repairs and for primers, but has sufficient output to cure all kinds of paint materials.

The IRT PcD by Hedson dryers are equipped with a control unit for computerized curing process. There is a program for each drying requirement and due to the easily understandable and self-instructional menu, program selection is quick and easy. 18 different languages can easily be set.

- Computerized curing process, 12 pre-set and 3 custom programs
- Unique possibilities to position the cassettes
- Electronic distance sensor
- Powerful ventilation that cools the cassette and increases lamp life

TECHNICAL DATA IRT 3-1 PCD	
Frequency	50-60 Hz
Current	8 A
Output power	3 kW
Fuse	16 A
Max. cassette height	2250 mm (h) 2550 mm (v)
Part.no.	Voltage
800450	400V, 3 PH, 4pin, EU
800451	400V, 3 PH, 5pin, EU
800447	230V, 3 PH, EU
800483	400V, 3 PH, AUS
800467	230V, 1 PH, NA ETL

TECHNICAL DATA IRT 3-2 PCD	
Frequency	50-60 Hz
Current	15 A
Output power	6 kW
Fuse	16 A
Max. cassette height	2250 mm (h) 2550 mm (v)
Part.no.	Voltage
800453	400V, 3 PH, 4pin, EU
800454	400V, 3 PH, 5pin, EU
800459	230V, 3 PH, EU
800455	400V, 3 PH, AUS
800484	200V, 3 PH, 4P, JP
800458	230V, 1 PH, NA ETL

CONSUMABLES	
Part.no.	Description
102699	Lamp-IR 2kW 235V 360 U CPL
102700	Lamp-IR 1kW 235V 360 U CPL
713576	IRT cassette air filter
713576-10	10 pcs IRT cassette air filter

CURING AREAS



IRT 3-1 PCD

One cassette at a distance of 600 mm, on black sheet metal

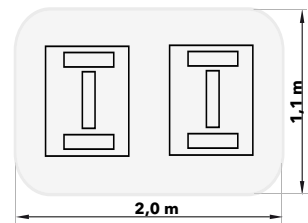

IRT 3-2 PCD

Two cassettes at a distance of 600 mm, on black sheet metal



IRT BY HEDSON

Basic features

	IRT 4-2 PcAuto	IRT 4-1 PcAuto	IRT 3-2 PcD	IRT 3-1 PcD	IRT 4 PrepCure	IRT 3 PrepCure	IRT 2 PrepCure	IRT 1 PrepCure
Even heat distribution	●	●	●	●	●	●	●	●
Short curing times	●	●	●	●	●	●	●	●
Environmentally friendly, efficient use of energy	●	●	●	●	●	●	●	●
24 carat gold coated reflectors with 97% reflection	●	●	●	●	●	●	●	●
Powerful ventilation provides the lamps with a service life of up to 20,000 operating hours	●	●	●	●	●	●	●	
FreeForm reflectors for an unsurpassed drying surface	●	●	●	●	●	●	●	
Efficient particle filter that creates a dust-free environment in the cassettes	●	●	●	●	●	●		
Enclosed cassette cables	●	●	●	●	●	●		
The angle of the arm provides increased reach	●	●	●	●	●			
The stand is adapted also to dry high cars, e.g. SUVs	●	●	●	●	●			
The arm is self-locking in all positions	●	●	●	●	●			
Electronic distance sensor	●	●	●	●				
Self-instructive programs	●	●	●	●				
Computerized curing process	●	●	●	●				
12 program pre-sets - 3 custom programs	●	●	●	●				
Programs for plastic/metal/water/solvent	●	●	●	●				
18 languages	●	●	●	●				
Pyrometer for exact temperature control	●	●						
Clear display with graphics showing the exact progress of the curing process	●	●						
Computerized temperature monitoring of curing process	●	●						
Laser circle indicates where temperature measurement takes place	●	●						

CURING BODY SHOP SOLUTIONS

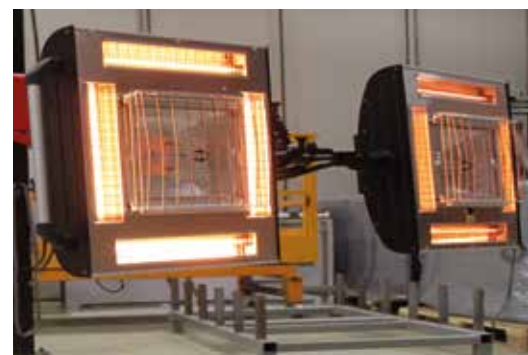

IRT UVA

Mobile UVA dryers with high intensity and outstanding curing performance of UVA paint materials

A mobile UVA dryer is an essential aid when curing UVA paint material on small and medium sized areas. The IRT UVA dryer works with UVA radiation. The ultraviolet light spectrum generated by the UVA-lamp interacts with special coating chemistries to produce a high-quality, durable curing.

Most importantly to achieve a good and fast curing result there must be enough UVA intensity. Our UVA products have an outstanding intensity to achieve the best curing result, even curing thick filler layers without problems. Our easily manoeuvrable UVA models are equipped with one or two compact high efficiency 1000 W UVA-lamps which make the curing extremely fast.

We also offer a combination of infrared and UVA lamps which can be run individually or in sequence. The combined models have IRT control units with programmed selection allowing quick access to a range of pre-set applications. Our UVA lamp design is ozone-free with protective glass that filters out UVB rays.

- Third party UV safety report (EN62471) for operator safety
- Ozone-free lamp design with protective glass that filters UVB/UVC-radiation
- High-quality and durable curing

HIGH EFFICIENCY UVA-LAMPS

Mobile UVA dryer for curing on vertical surfaces

The cassette is equipped with one UVA-lamp and a uniquely designed reflector for the best reflection of the UVA radiation and a superior radiation distribution over the curing area.

- Designed to cure UVA paint on vertical surfaces
- Powerful ventilation and efficient particle filter extends operating life
- The curing time is regulated with an electronic timer
- Time counter for the life length of the UVA lamp

CURING AREAS

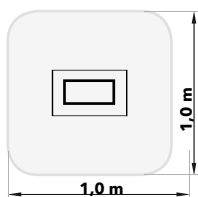

IRT UVA 1 PREPCURE 3
 One cassette at a distance of 550 mm with an UV-A intensity of 25mW/cm².

TECHNICAL DATA	
Voltage	230V 1Ph ~/PE
Frequency	50 Hz
Power	1 kW UV-A
Fuse	10 A
Max. cassette height	1310 mm
Part.no.	800604

CONSUMABLES	
Part.no.	Description
129070	UV/IR Protective glasses
712894	Air filter for UVA
712894-10	10 pcs air filter pack UVA
714599	UV-lamp replacement kit 230V 1 kW (UVA)



IRT UVA 1 PrepCure 3

**ALWAYS USE SAFETY GLASSES WHEN HANDLING UV LIGHT.
 WE SUPPLY A PAIR WITH EACH DELIVERED UNIT.**

HIGH-QUALITY DURABLE CURING

Flexible stand enabling curing of roofs on high vehicles

Each cassette is equipped with one UVA lamp and a special designed reflector for the best reflection of the UVA radiation and a superior radiation distribution over the curing area. These mobiles reach up to 2,240 mm adequate for drying most roof surfaces.

- The curing time is regulated with an electronic timer
- Powerful ventilation and efficient particle filter extends operating life
- Time counter for the life length of the UVA lamp
- Easily maneuverable design, combined with a gas spring, simplifies cassette adjustment

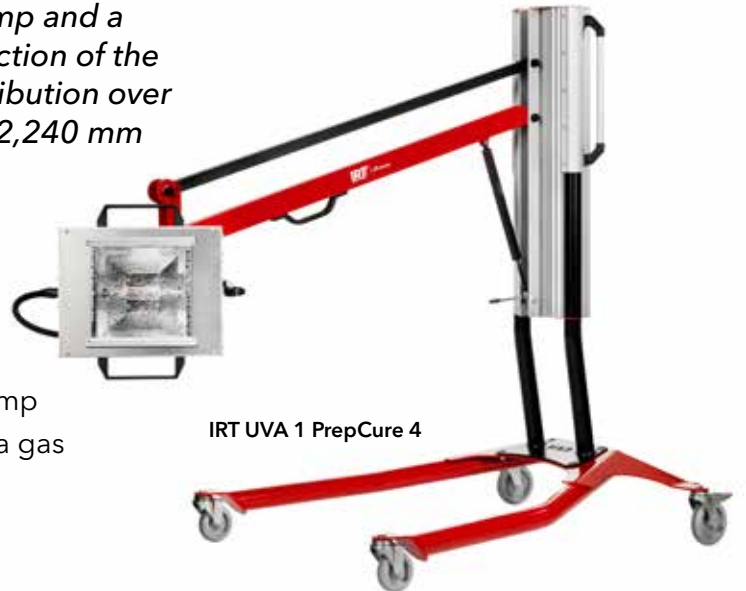

CURING AREAS

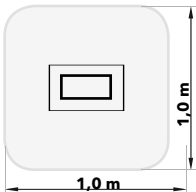

IRT UVA 1 PREPCURE 4
One cassette at a distance of 550 mm with an UV-A intensity of 25mW/cm².

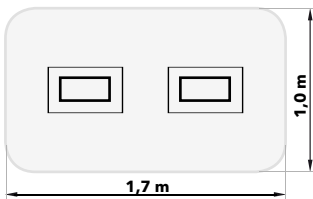

IRT UVA 2 PREPCURE 4
Two cassettes at a distance of 550 mm with an UV-A intensity of 25mW/cm².

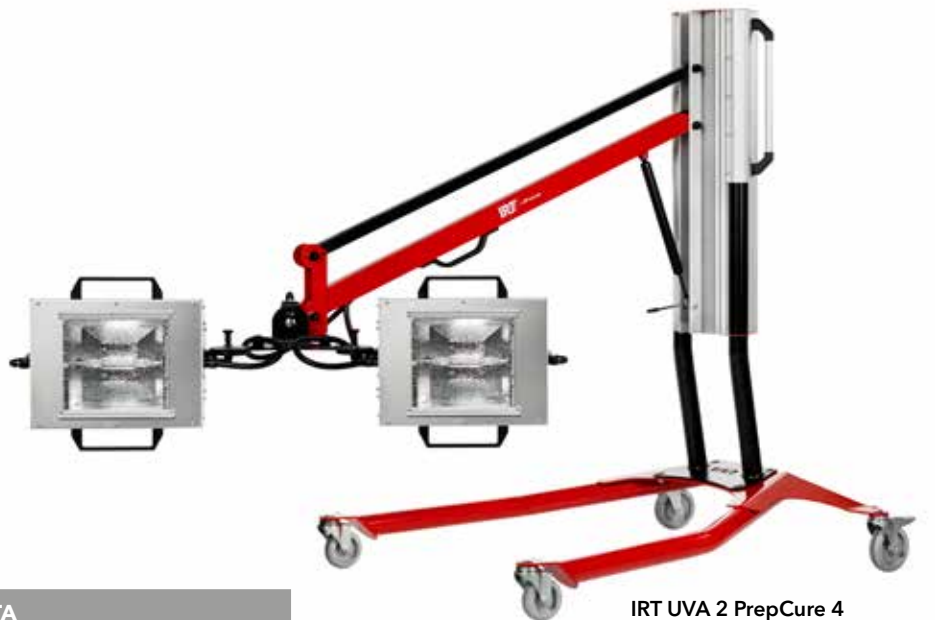

TECHNICAL DATA		
	IRT UVA 1 PrepCure 4	IRT UVA 2 PrepCure 4
Voltage	230V 1Ph ~/PE	230V 1Ph ~/PE
Frequency	50 Hz	50 Hz
Power	1 kW UV-A	2 kW UV-A
Fuse	10 A	10 A
Max. cassette height	2240 mm	2240 mm
Part.no.	800621	800622

CONSUMABLES	
Part.no.	Description
129070	UV/IR Protective glasses
712894	Air filter for UVA
712894-10	10 pcs air filter pack UVA
714599	UV-lamp replacement kit 230V 1 kW (UVA)

COMBINATION OF IR AND UVA CURING

Unique mobile dryers offer shortwave infrared and UVA radiation for all your curing needs

The combination of shortwave infrared and UVA radiation makes this mobile dryer unique. One cassette includes 4 IR lamps and 1 UVA lamp. These mobile UV dryers are featured with 15 (IR:12, UV: 3) pre-programmed programs for water and solvent based paint material, from putty to clear coat.

- IR and UVA can be run individually and in sequence
- The infrared lamps are mounted in gold surface reflectors, reflecting up to 98 % of the short-wave radiation
- The IRT control unit includes program selection
- Time counter for the life length of the lamps



IRT Combi 4-1 IR-UVA

CURING AREAS - UVA

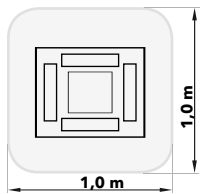

IRT COMBI 4-1 IR-UVA
One cassette at a distance of 550 mm with an UV-A intensity of 25mW/cm².

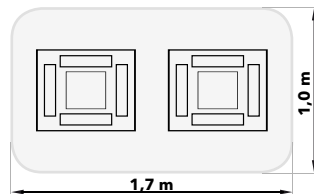

IRT COMBI 4-2 IR-UVA
Two cassettes at a distance of 550 mm with an UV-A intensity of 25mW/cm².

CURING AREAS - IR

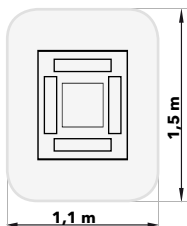

IRT COMBI 4-1 IR-UVA
One cassette at a distance of 600 mm, on black sheet metal

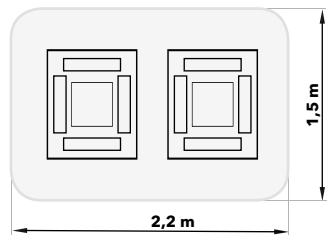

IRT COMBI 4-2 IR-UVA
Two cassettes at a distance of 600 mm, on black sheet metal



IRT Combi 4-2 IR-UVA

TECHNICAL DATA		
	IRT Combi 4-1 IR-UVA	IRT Combi 4-2 IR-UVA
Voltage	380-420V 3 Ph/PE	380-420V 3 Ph/PE
Frequency	50 Hz	50 Hz
Power	IR: 6 kW UVA: 1 kW	IR: 12 kW UVA: 2 kW
Fuse	10 A	16 A
Current	IR: 9 A UVA: 3 A	IR: 16 A UVA: 6 A
Max. cassette height	2240 mm	2240 mm
Part.no.	800605	800606

CONSUMABLES	
Part.no.	Description
129070	UV/IR Protective glasses
712894	Air filter for UVA
712894-10	10 pcs air filter pack UVA
714842	UV-lamp replacement kit 400V 1,2 kW (Combi IR-UVA)
102700	Lamp-IR 1kW 235V 360 U CPL
713576	IRT cassette air filter
713576-10	10 pcs IRT cassette air filter

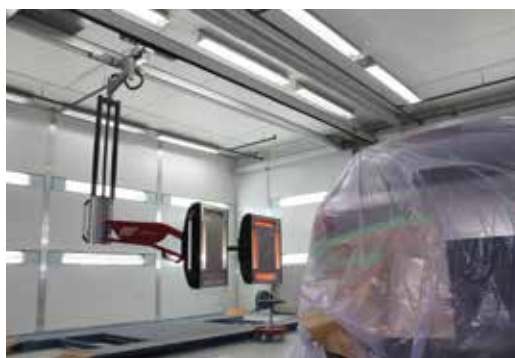

IRT RAIL SYSTEMS

Simple and space saving high quality curing rail system customized for workshops and assembly lines

Reaching and maintaining the highest quality curing results have never been easier. With an IRT Rail System by Hedson, quickly maneuver the heater into the perfect curing position, reaching all parts of the vehicle.

The rails can be equipped with any number of heaters, all hanging on easy-glide, self-balanced cassette arms. Precious space between the vehicles can be saved, and no loose or trailing cables on the floor disturb the work process.

If there are obstructions around the suspension points/ceiling, such as ventilation, construction beams etc., underhung cross rail-system is more suitable.

Adapt the IRT Rail system with our Dust and surveillance

system for even more protection for the worker. The system is used in enclosed spray booth or combined spray and dry booth, and has two functions; protection of the IR-cassettes by retraction into dustcovers (when those are not operated) and security-oriented control of the IR-drying unit.

- Adapted for the preparation area and the spray booth
- The cross rail system can be installed to the wall or ceiling
- Can be customized to suit all workshops
- Dryers suitable for the IRT Rail Systems are IRT 3-20, IRT 4-10 / 4-20 and IRT IR/UV COMBI* 4-10 / 4-20

CROSS RAIL AND WALLMOUNTED SYSTEMS

Rail systems tailor-made to suit different working areas

CURING BODY SHOP SOLUTIONS



Sidehung cross rail system (Standard)

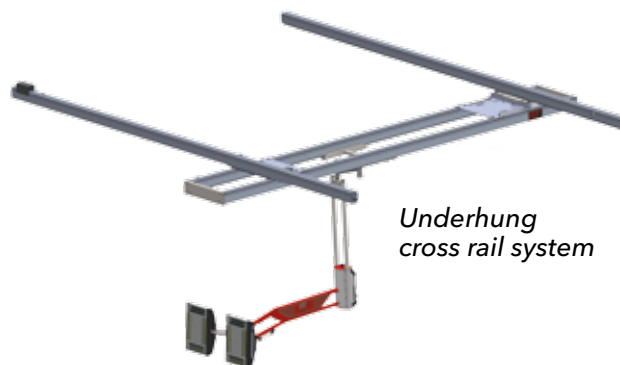

Underhung cross rail system



Rail system

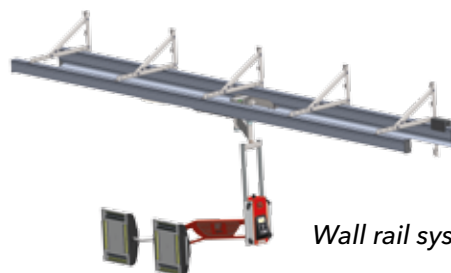

Wall rail system

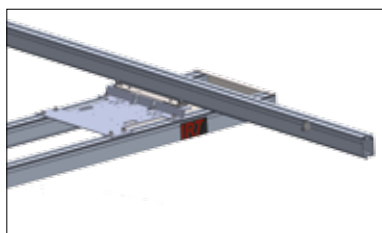
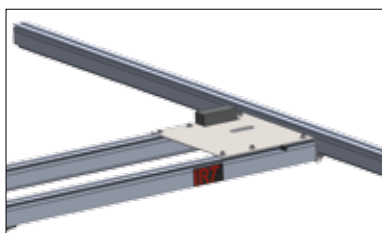

Left: standard sidehung cross rail system. Right: underhung cross rail system. The cross rail system can be installed to the wall or ceiling. If there are obstructions around the suspension points/ceiling, such as ventilation, construction beams etc., the underhung cross rail system is more suitable.

TECHNICAL DATA

Side rail set	a) 1-28 m, 1 x 100 A b) 10-30 m, 2 x 100 A
Cross rail incl. swing arm	a) 1-7 m 400 V 3 Ph b) 1-7 m 230 V 3 Ph
Cross rail kit	a) Standard sidehung b) Underhung
Wall rail set	a) 1-20 m 400 V 3 Ph b) 1-10 m 230 V 3 Ph
Vertical arm installation height (m)	a) 2,25-3,40 b) 2,25-3,15 c) 2,25-2,70 (*For IR/UV COMBI: a) 2,65-3,40 b) 2,65-3,15 c) 2,65-2,70)
Rail Dryer	IRT 3-20 PcD: 400 V 3 Ph 6 kW IRT 3-20 PcD: 230 V 3 Ph 6 kW IRT 4-20 PcD: 400 V 3 Ph 12 kW IRT 4-20 PcD: 230 V 3 Ph 12 kW IRT IR/UV COMBI 4-20 400 V 3 Ph
Fuse	32 A: 230 V < 2 cassettes, 400 V < 4 cassettes 63 A: 230 V < 4 cassettes, 400 V < 8 cassettes 100 A: 230 V < 6 cassettes, 400 V < 12 cassettes

EXCELLENT FIT IN LIMITED AREAS

Dryers with high output and capacity adapted for the IRT rail system by Hedson

These dryers are suspended in permanently installed rails and is easy gliding and self-balancing, both laterally and vertically in all directions. As the electric power supply is integrated in the rails, there are no loose cables dragging along the floor disrupting work and stirring up dust.

The cassettes are easy to adjust into the correct position. The heater lamps are rigidly set in precision gold coated reflector bodies, ensuring the most even and efficient heat distribution. All lamps are cooled by ventilator fans.

Drying time and power is controlled by a microprocessor which is, pre-programmed for different types of paints, automatically handles the entire curing process.

Hedson offers 5 different dryers suitable for the IRT Rail Systems.

- No cables on the floor - free areas
- Electric power supply integrated into the rails
- Excellent fit in tight areas between cars
- Less risk for unintentional damage to the car
- No bulky equipment to move around the shop

CURING TIMES	
Putty	5-6 min
Filler, bright	10-15 min
Filler, dark	10-15 min
Water-based paint	4-6 min
Base coat	4-8 min
Top coat	10-15 min
Clear coat	10-15 min
Plastic filler	10-15 min
Plastic top coat	13-17 min
Plastic clear coat	13-17 min
Final boost	2-4 min
Soft cure	13-17 min

The curing times are extremely short. The times above apply to the IRT PcAuto series. Add a minute or two for other models.



IRT 3-20 PCD

Adapted for the prep station and the spray booth

The IRT 3-20 Pcd by Hedson dryers are equipped with a control unit for computerized curing process. There is a program for each drying requirement and due to the easily understandable and self-instructional menu, program selection is quick and easy.

- Computerized curing process, 12 pre-set and 3 custom programs
- Unique possibilities to position the cassettes
- Electronic distance sensor
- Powerful ventilation that cools the cassette and increases lamp life



CURING BODY SHOP SOLUTIONS

CURING AREAS

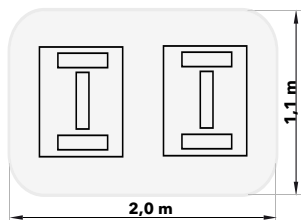

IRT 3-20 PCD
Two cassettes at a distance of 600 mm, on black sheet metal

CONSUMABLES IRT PCD & PCAUTO

Part.no.	Description
102699	Lamp-IR 2kW 235V 360 U CPL
102700	Lamp-IR 1kW 235V 360 U CPL
713576	IRT cassette air filter
713576-10	10 pcs IRT cassette air filter

TECHNICAL DATA - IRT 3-20 PCD		
Voltage	200-230V 3Ph/PE	400V 3Ph/PE
Frequency	50-60 Hz	50-60 Hz
Current	15 A	9 A
Output power	6 kW	6 kW
Fuse	16 A	16 A
Part.no.	800477 (EU, JP)	800463 (EU)

IRT 4-10 / 4-20 PCAUTO

Equipped with user friendly advanced technology

IRT 4-10 and 4-20 Pcauto by Hedson has the same features as IRT 4-1 and 4-2 Pcauto and are easy to use and the curing time is reduced to a minimum. The dryers are equipped with advanced technology such as a temperature measurement, laser circle and ultrasonic distance sensor. 18 different languages can easily be set.

- Computerized curing process, 12 pre-set and 3 custom programs
- Pyrometer for exact temperature control
- Laser circle indicates where temperature measuring takes place
- Electronic distance sensor

CURING AREAS

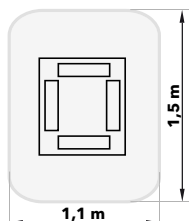

IRT 4-10 PCAUTO
One cassette at a distance of 600 mm, on black sheet metal

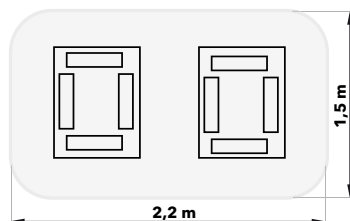

IRT 4-20 PCAUTO
Two cassettes at a distance of 600 mm, on black sheet metal



TECHNICAL DATA - IRT 4-10 PCAUTO			
Voltage	200-230V 3Ph/PE	400V 3Ph/PE	440-480V 3Ph/PE
Frequency	50-60 Hz	50-60 Hz	50-60 Hz
Current	15 A	9 A	9 A
Output power	6 kW	6 kW	6 kW
Fuse	16 A	10 A	20 A
Part.no.	800525 (NA, ETL)	800489 (EU)	800494 (NA, ETL)

TECHNICAL DATA - IRT 4-20 PCAUTO				
Voltage	200-230V 3Ph/PE	200-230V 3Ph/PE	400V 3Ph/PE	440-480V 3Ph/PE
Frequency	50-60 Hz	50-60 Hz	50-60 Hz	50-60 Hz
Current	30 A	30 A	17 A	17 A
Output power	12 kW	12 kW	12 kW	12 kW
Fuse	32 A	32 A	16 A	20 A
Part.no.	800480 (EU, JP)	800498 (NA, ETL)	800464 (EU)	800479 (NA, ETL)

IRT COMBI 4-10 & 4-20 IR-UVA

Unique mobile dryer due to the combination of short-wave infrared and UVA radiation

The combination of shortwave infrared and UVA radiation makes this mobile dryer unique. One cassette includes 4 IR lamps and 1 UVA lamp. These mobile UV dryers is featured with 15 (IR:12, UV: 3) pre-programmed programs for water and solvent based paint material, from putty to clear coat.

- IR and UVA can be run individually and in sequence
- The infrared lamps are mounted in gold surface reflectors, reflecting up to 98 % of the short-wave radiation
- The IRT control unit includes program selection
- Time counter for the life length of the lamps



TECHNICAL DATA		
	IRT Combi 4-10 IR-UVA	IRT Combi 4-20 IR-UVA
Voltage	380-420V 3 Ph/PE	380-420V 3 Ph/PE
Frequency	50 Hz	50 Hz
Power	IR: 6 kW UVA: 1 kW	IR: 12 kW UVA: 2 kW
Fuse	Max 100 A	Max 100 A
Current	IR: 9 A UVA: 3 A	IR: 16 A UVA: 6 A
No. of cassettes	1	2
Max. cassette height	2240 mm	2240 mm
Part.no.	800618	800619

CURING AREAS - UVA

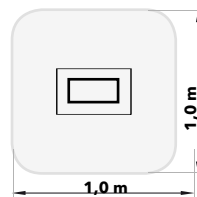

IRT COMBI 4-10 IR-UVA

One cassette at a distance of 550 mm with an UV-A intensity of 25mW/cm².

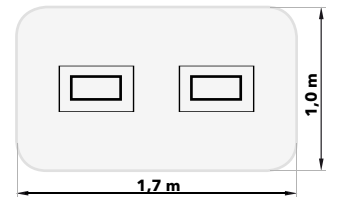

IRT COMBI 4-20 IR-UVA

Two cassettes at a distance of 550 mm with an UV-A intensity of 25mW/cm².

CURING AREAS - IR

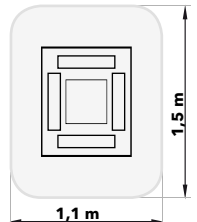

IRT COMBI 4-10 IR-UVA

One cassette at a distance of 600 mm, on black sheet metal

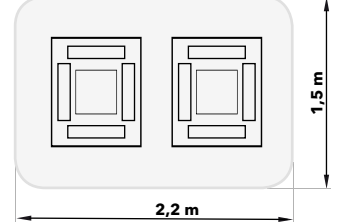

IRT COMBI 4-20 IR-UVA

Two cassettes at a distance of 600 mm, on black sheet metal

IRT RAIL SYSTEMS

Put together your IRT rail system

IRT CROSS RAIL SYSTEM
PLEASE SPECIFY BELOW TO ORDER
<ul style="list-style-type: none"> ■ Side Rail ■ Standard Sidehung or Underhung Kit ■ Cross Rail ■ Vertical Arm ■ Rail Dryer (See previous pages for part.no.) ■ Main Switch ■ Dust cover (spray booth only)
IRT RAIL SYSTEM WITHOUT CROSS RAIL
PLEASE SPECIFY BELOW TO ORDER
WALL OR CEILING MOUNTED
<ul style="list-style-type: none"> ■ Side Rail ■ Suspension kit for wall or suspension ■ Trolley cpl ■ Vertical Arm ■ Rail Dryer (See previous pages for part.no.) ■ Main Switch ■ Dust cover (spray booth only)

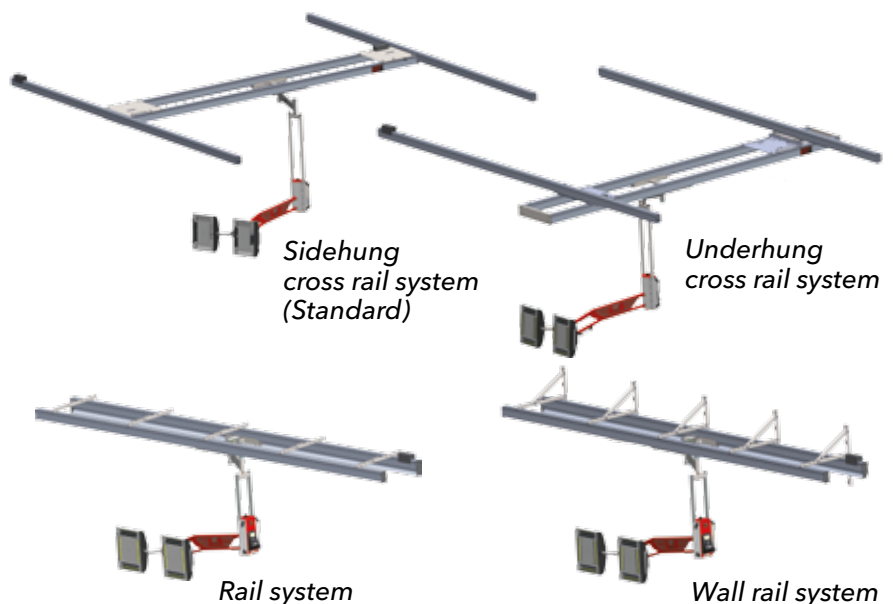

SIDE RAILS SET			
<i>Can be loaded with 100 A = 12 pcs of 400-480 V cassettes or 6 pcs of 230 V cassettes</i>		<i>Can be loaded with 200 A (2 x 100 A) = 24 pcs of 400-480V cassettes or 12 pcs of 230 V cassettes</i>	
Part.no.	Description	Part.no.	Description
711986	0-4 m, Rail bolt 8 pcs	712234	10-11 m
711987	4-5 m, Rail bolt 10 pcs	712268	11-12 m
711988	5-6 m, Rail bolt 10 pcs	712269	12-13 m
711989	6-7 m, Rail bolt 12 pcs	712270	13-14 m
711990	7-8 m, Rail bolt 14 pcs	712271	14-15 m
711991	8-9 m, Rail bolt 14 pcs	712272	15-16 m
711992	9-10 m, Rail bolt 16 pcs	712273	16-17 m
711993	10-11 m, Rail bolt 18 pcs	712274	17-18 m
711994	11-12 m, Rail bolt 18 pcs	712275	18-19 m
711995	12-13 m, Rail bolt 20 pcs	712276	19-20 m
711996	13-14 m, Rail bolt 22 pcs	712308	20 m and above
711997	14-15 m, Rail bolt 22 pcs		
711998	15-16 m, Rail bolt 24 pcs		
711999	16-17 m, Rail bolt 24 pcs		
712000	17-18 m, Rail bolt 26 pcs		
712001	18-19 m, Rail bolt 26 pcs		
712002	19-20 m, Rail bolt 28 pcs		
712079	20-22 m, Rail bolt 32 pcs		
712080	22-24 m, Rail bolt 34 pcs		
712081	24-26 m, Rail bolt 38 pcs		
712082	26-28 m, Rail bolt 40 pcs		
712083	28-30 m, Rail bolt 42 pcs		
714811	30-34 m, Rail bolt 46 pcs		

SIDEHUNG / UNDERHUNG CROSS RAIL KIT	
Part.no.	Description
714586	Underhung cross rail kit
714587	Sidehung cross rail kit (Standard)

VERTICAL ARM (INSTALLATION HEIGHT)	
Part.no.	Description
713990	2,25 to 3,40 m
713910	2,25 to 3,15 m
713911	2,25 to 2,7 m

CROSS RAIL SET (INCL. SWINGARM)	
<i>400-480 V, 3 Ph</i>	
Part.no.	Description
713934	0-4 m
713935	4-5 m
713936	5-6 m
713937	6-7 m
<i>230 V, 3 Ph</i>	
Part.no.	Description
713938	0-4 m
713939	4-5 m
713940	5-6 m
713941	6-7 m

MAIN SWITCHES	
Part.no.	Description
121512	32A 230V < 2 cassettes 400-480V < 4 cassettes
121806	63A 230V < 4 cassettes 400-480V < 8 cassettes
190146	100A 230V < 6 cassettes 400-480V < 12 cassettes

TROLLEY CPL	
Part.no.	Description
714724	Trolley for wall or ceiling mounted rail system (Quantity: 1/dryer)

RAIL EXTENSION KIT	
Part.no.	Description
190057	0-4 m
190058	4-6 m
190059	6-7 m
190060	Splice kit

SUSPENSION KIT FOR INSTALLATION	
Part.no.	Description
714719	Wall system, 1pcs Siderail Rail bolt / 2
714721	Rail system, 1pc Siderail Rail bolt / 2

DUST COVER AND SURVEILLANCE SYSTEM	
Part.no.	Description
800597	Dust cover and Surveillance System (only for spray booth), incl. 800154 400 V, 3 Ph (not ETL), 2 cassettes

DUST COVER	
Part.no.	Description
800664	Dust cover wall mounted (IRT 3-10 and 4-10)
800665	Dust cover wall mounted (IRT 3-20 and 4-20)

WALL BRACKETS FOR INSTALLATION A SIDE RAIL TO A WALL	
Part.no.	Description
800154	Wall brackets, 14 pcs
710222	Wall bracket, 1 pcs



IRT POWERCURE

Save energy, time and space with the perfect solution for paint booth curing

With IRT PowerCure the car can be returned in the shortest possible time. IRT PowerCure drastically shortens the curing times for all paint materials with a minimum of energy used.

Radically reduce the energy consumption and pay off the investment in a very short time. IRT PowerCure will only heat and cure the selected panels of the car. IRT PowerCure keeps track of position and status of the curing process and will turn on- and off the individual lamps in a fraction of a second, to only use the energy needed for the curing job.

When the painter has completed the finishing job and exits the spray booth he makes a short stop in front of the touch screen operator panel. This is where selections of panels to be dried and paint type are done quickly and easily.

A typical coating is cured in 10 minutes or less. Leave the car for another 10 minutes to cool down. It can then be removed from the spray booth, polished and processed

further. IRT PowerCure turns your traditional booth into a rapid curing booth.

The IRT PowerCure saves investing in a second or third booth. By curing the paint from the inside and out without retaining solvents and moisture, the car can be polished and processed further immediately after cool down.

The IRT-system does not heat up the air in the spray booth. The operator can re-enter the spray booth immediately after the curing process has been completed. The vehicle can directly be taken out of the booth.

The shape and positioning of the reflectors give an even heat distribution. The front and back of the vehicle are easily cured with the wing angled towards the painted surface.

The vehicle and loose parts can be cured in the same drying cycle. Loose parts are easy to cure. The IRT PowerCure detects the starting position and saves energy by only activating the necessary IR lamps. Simply choose the desired panels to be dried and start the curing process.

EFFICIENT CURING IN THE PAINT BOOTH

Simply choose the desired panels to be dried and start the curing process

The IRT PowerCure can be installed in a spray booth (IRT PowerCure Single) and between two in-line placed spray booths (IRT PowerCure Double). It is easy to adapt to all types of booths, due to the suspension by rails attached to the spray booth walls. Further the IRT PowerCure is designed to dry 1-3 panels of the vehicle and for loose parts. During spraying, the arch can be separated from the spray booth by an automatic roller door (option).

- Automatically moves to the right position corresponding to the chosen panels
- The front and the back of the vehicle are easily cured as the wings can be angled towards the painted surface
- The shape and positioning of the reflectors give an even heat distribution
- The vehicle and loose parts can be cured in the same drying cycle thanks to the intelligent software technology

OPTIONS

- Roller door/parking garage to protect the IR lamps
- Additional lamp for increased height (SUV)
- Position the PowerCure parking station at far end of booth or in the opening, based on electrical and mechanical parameters



IRT PowerCure by Hedson standard height (Optional: wing extension +200 mm)



INTELLIGENT SOFTWARE TECHNOLOGY

- The control equipment includes sensors and microprocessors which register and regulate power output, speed, distance and times
- Adapts to different paint materials as well as the size and shape of the car
- Effective heating of selected zones adjusted by means of a laser distance sensor
- Advanced ventilation adds to IRT lamp life cycle, >20,000 working hours/lamp

SAFETY FEATURES

- Overspray protection and safety surveillance system, connected to the spray booth ventilation and the spray gun air supply, ensure a safe operation
- Emergency stop for installation next to operator panel
- Operator always confirms EMPTY BOOTH before start
- Emergency switches on doors included in delivery, activates if doors are opened during curing process
- Warning signs for doors included in delivery



CURING BODY SHOP SOLUTIONS

DIMENSIONS

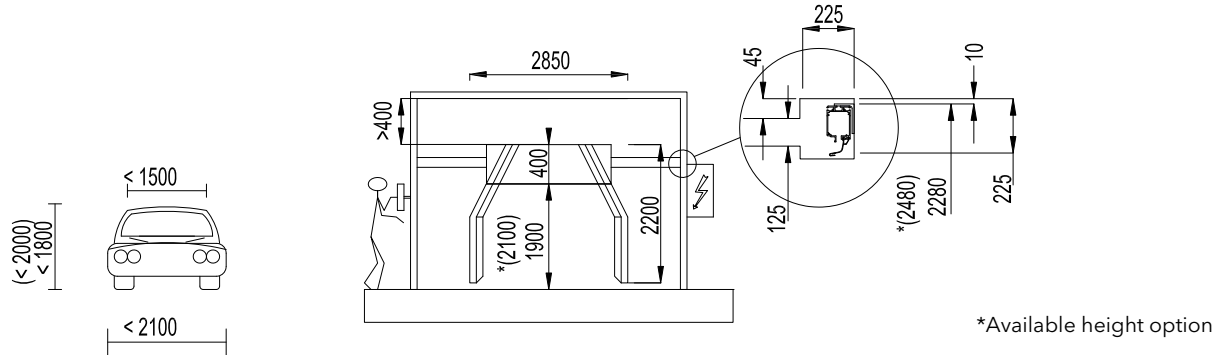

IRT POWERCURE SINGLE

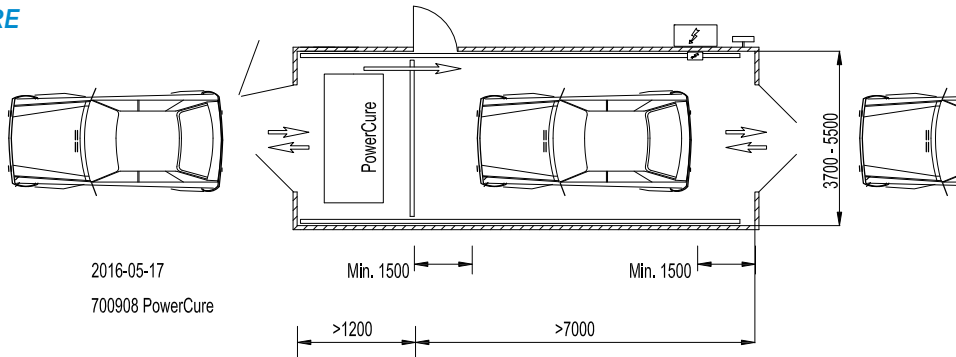

IRT POWERCURE DOUBLE

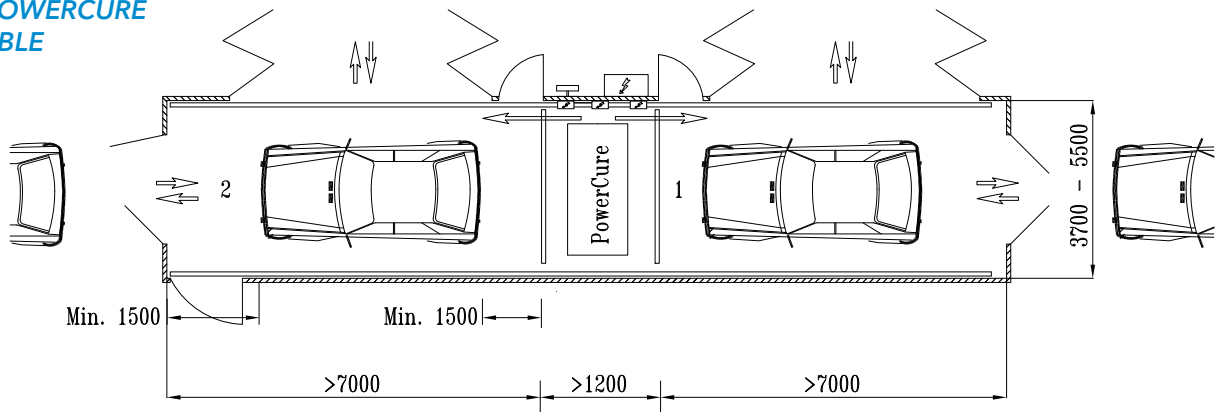

TECHNICAL DATA

Installed power	54 kW / 63 A (20 lamps à 3 kW less 6 kW supply voltage compensation)	
Voltage	400 V, 3Ph ~/PE	
Frequency	50-60 Hz	

CURING TIMES

Medium-sized vehicles		
	Base coat (approx.)	Clear coat (approx.)
Bonnet	4 min	7 min
Door	3 min	5 min

ENERGY CONSUMPTION

Typical energy consumption, clear coat on base coat, medium sized vehicle, medium colour shade:

Front wing	6 min	0,95 kWh
Door	5 min	0,95 kWh
Front wing + door	10 min	1,6 kWh
Hood	7 min	1,5 kWh
Hood + 2 wings	9 min	2,8 kWh
Complete car	26 min	15,8 kWh



The PowerCure in these images is equipped with the optional additional lamp for extra height.

IRT POWERCURE	
<i>Incl. Surveillance System</i>	
Part.no.	Description
800410	IRT PowerCure Single
800490	IRT PowerCure Double
OPTIONS	
Part.no.	Description
800488	IRT PowerCure wing extension (SUV Extension)
713876	Parking arch, complete
713883	Extension parking arch, together with 800488

SIDE RAILS SET - IRT POWERCURE	
Part.no.	Description
713945	7-8 m, Single
713946	8-9 m, Single
713947	9-10 m, Single
713948	10-11 m, Single
714041	11-12 m, Single
713900	14-15 m, Double
713901	15-16 m, Double
713902	16-17 m, Double
713903	17-18 m, Double



DRESTER GUN CLEANERS BY HEDSON

Durable and flexible gun cleaners that are easy to use with an excellent cleaning performance

Drester by Hedson offer several standard gun cleaners that are easy to use, fast and gives a superior cleaning result, all to meet the needs that are specific to different sizes of body shops.

Drester by Hedson has been at the very forefront of developing spray gun cleaners, ever since it made the world's first gun cleaner. With a very broad range, Drester by Hedson offer gun cleaners to suits every need in the workshop.

HIGHEST POSSIBLE SAFETY

The environment in which a gun cleaner operates requires components with quite special features. Therefore, Drester by Hedson have developed an unparalleled range of reliable, durable components, specifically designed for gun cleaners. All Drester by Hedson gun cleaners fulfill the latest legislations and offer the highest possible safety.

EXCELLENT CLEANING PERFORMANCE

The unbeatable wash power is possible with unique Drester pump and the special Drester spray nozzles. A perfectly clean spray gun is essential for doing a professional spray job. The time spent cleaning the gun and handling the waste can be reduced by choosing appropriate equipment. Drester by Hedson has developed functions specially intended to make your work as efficient as possible.

- Certified and patented products with superior quality
- Swedish inventions that satisfy customer needs
- Superior range of key components



QUALITY, PERFORMANCE AND RELIABILITY

Superior gun cleaners to fit all the needs in the body and paint shop

With decades of experience in designing and manufacturing complex components, Drester by Hedson has created a superior range of key components, specifically designed for use in gun cleaners. Thereby, Drester by Hedson has continued to raise the bar, and any Drester by Hedson gun cleaner ensures unequalled quality and performance.

They are all equipped with an Auto box - a compact, effective and flexible washing compartment - with integrated fluid channels, which makes less-cluttered space. The power of the pump results in more efficient cleaning, meaning that less cleaning solvents are needed per gun. The Auto box is located at the back of the unit, allowing a spacious manual washing sink at the front. At the same time as a gun is being cleaned automatically in the Auto box, manual cleaning is available, with a flow-through brush and a clean rinse nozzle.

All Drester Boxer by Hedson gun cleaners also feature a patented magnetic gun holder which simplifies the cleaning and use of the gun cleaner. The magnetic gun holder pulls the trigger to open the paint channel and fixates a gun in seconds, in one simple step. It fixates the gun in a position where the gun's air channels are protected, facing downwards, so there is no risk of solvent entering the air channels.

The Drester Boxer by Hedson series offers models for all needs; solvent-based, water-borne or a combination of solvent-based and water-borne cleaning.

- Equipped with an air pressure regulator and water trap for durability
- Specifically, designed spray nozzles to give an optimal wash power
- Foot-operated pumps for hands-free operation and to reduce the solvent consumption



RELIABLE AND SUSTAINABLE

Gun cleaners with the possibility with solvent-based and water-based cleaning

With the Drester Box Combo gun cleaners it's possible for both solvent-based and water-borne cleaning. Drester Boxer combo cleaning offers three models, a compact-size unit and two full-size units.

- Suitable for solvent-based and water-based cleaning
- Automatic agitation when flocculating
- Compact or full-size models



Boxer Double Combo



Boxer Triple Combo



Boxer Quattro Combo

TECHNICAL DATA			
	Boxer Double Combo	Boxer Triple Combo	Boxer Quattro Combo
Compressed air needed	7-12 bar (110-180 psi) 250 l/min (9 cfm)	7-12 bar (110-180 psi) 250 l/min (9 cfm) (450 l/min (16 cfm) with DRESTER AIRVENT 11660)	7-12 bar (110-180 psi) 250 l/min (9 cfm) (450 l/min (16 cfm) with DRESTER AIRVENT 11660)
Ventilation capacity required		500 m³/h (310 cfm)	800 m³/h (500 cfm)
- with a 15 m extension	140 m³/h (82 cfm)		
- with a 5 m extension	148 m³/h (106 cfm)		
Weight	65 kg (140 lb)	95 kg (210 lb)	105 kg (230 lb)
Overall dimensions			
- Height	1510 mm (59.5")	1510 mm (59.5")	1510 mm (59.5")
- Width	835 mm (33.0")	1185 mm (46.7")	1185 mm (46.7")
- Max depth	650 mm (25.5")	650 mm (25.5")	650 mm (25.5")
- Depth at the floor	610 mm (24.0")	610 mm (24.0")	610 mm (24.0")
Extractor diameter	80 mm (3.15")	125 mm (5")	125 mm (5")
Part.no. (standard unit)	DB22C DI22C (stainless steel)	DB33C DI33C (stainless steel)	DB44C DI44C (stainless steel)
<i>(For extra features - please contact your local distributor or Hedson contact)</i>			

CONSUMALBES	
Part.no.	Description
230120	AquaSolve
9211	Flocculation powder
R8701	Main filter (5 pcs.)
R8702	Pre-filter (5 pcs.)

OPTIONS	
Part.no.	Description
2050	Minivent (3ph. 380V, 250W)
2055	Minivent (3ph. 415V, 250W)
1294	Minivent (1ph. 230V, 250W)
11660	Airvent
15650	Magnetic gun holder
15640	Kit for suction-fed gun
10455	Extension tube
17270	Adapter for side-fed gun
13136	Flow-through wash brush
R4466	Wash brush (3pcs of 13136)
15610	Foldable lid (DB33C, DB44C)
15620	Water valve kit (DB22C, DB33C)
15630-1	Plexiglass (DB44C)
15630-3	Plexiglass (DB33C)
8910	3-minute kit
10960	Collecting tray (DB33C)

INCREASE THE PROFITABILITY

Cleaning process with re-circulating solvent and clean solvent, which saves time and solvent

The Drester boxer solvent cleaning process together with the unparalleled reliability and durability, makes the Drester by Hedson equipment a better choice and an investment that will increase the profitability. These gun cleaners are also equipped with hoods for protections from splashing and enable different types of ventilation: Drester Airvent, Drester Minivent or central ventilation.

Drester Boxer for solvent-based cleaning offers two models; a compact-size unit and a full-size unit.

- Suitable for solvent-based cleaning
- Equipped with hoods for protections from splashing
- Compact or full-size models



Boxer Double Solvent



Boxer Quattro Solvent

TECHNICAL DATA		
	Boxer Double Solvent	Boxer Quattro Solvent
Compressed air needed	7-12 bar (110-180 psi) 150 l/min (6 cfm)	7-12 bar (110-180 psi) 150 l/min (6 cfm) (450 l/min (16 cfm) with DRESTER AIRVENT 11660)
Ventilation capacity required	500 m ³ /h (310 cfm)	800 m ³ /h (500 cfm)
Weight	75 kg (165 lb)	105 kg (230 lb)
Overall dimensions		
- Height	1510 mm (59.5")	1510 mm (59.5")
- Width	835 mm (33.0")	1185 mm (46.7")
- Max depth	650 mm (25.5")	650 mm (25.5")
- Depth at the floor	610 mm (24.0")	610 mm (24.0")
Extractor diameter	125 mm (5")	125 mm (5")
Part.no. (standard unit)	DB22S DI22S (stainless steel)	DB44S DI44S (stainless steel)

(For extra features - please contact your local distributor or Hedson contact)

OPTIONS	
Part.no.	Description
2050	Minivent (3ph. 380V, 250W)
2055	Minivent (3ph. 415V, 250W)
1294	Minivent (1ph. 230V, 250W)
11660	Airvent
15650	Magnetic gun holder
15640	Kit for suction-fed gun
10455	Extension tube
17270	Adapter for side-fed gun
13136	Flow-through wash brush
R4466	Wash brush (3pcs of 13136)
15610	Foldable lid
8910	3-minute kit
15630-1	Plexiglass
15630-2	Plexiglass
10960	Collecting tray

CLEANING
BODY SHOP SOLUTIONS

EFFICIENT CLEANING PROCESS

Water-borne gun cleaner that easily removes the hard paints with the flow-through brush

The time spent cleaning the gun and handling the waste can be reduced by choosing appropriate equipment. The Drester Boxer Aqua cleaner are equipped with functions specifically intended to make the work as efficient as possible. Example: automatic agitation of the water during flocculation, automatic evacuation of the waste water. The Drester Boxer Aqua gun cleaners are equipped with a flow-through brush, which is fed with recycled water to easier remove the hard water-borne paints.

Drester Boxer for water-borne cleaning offers one model; a compact-size unit with two working stations.

- Suitable for water-based cleaning
- Automatic agitation when flocculating
- Compact-size model



Boxer Double Aqua

TECHNICAL DATA		OPTIONS		CONSUMABLES	
Compressed air needed	7-12 bar (110-180 psi) 250 l/min (9 cfm)	Part.no.	Description	Part.no.	Description
Extraction capacity		2050	Minivent (3ph. 380V, 250W)	230120	AquaSolve
- with 15 m extension	140 m ³ /h (82 cfm)	2055	Minivent (3ph. 415V, 250W)	9211	Flocculation powder
- with 5 m extension	180 m ³ /h (106 cfm)	1294	Minivent (1ph. 230V, 250W)	R8701	Main filter (5 pcs.)
Weight	65 kg (140 lb)	15650	Magnetic gun holder	R8702	Pre-filter (5 pcs.)
Overall dimensions		15640	Kit for suction-fed gun		
- Height	1510 mm (59.5")	10455	Extension tube		
- Width	835 mm (33.0")	17270	Adapter for side-fed gun		
- Max depth	650 mm (25.5")	13136	Flow-through wash brush		
- Depth at the floor	610 mm (24.0")	R4466	Wash brush (3pcs of 13136)		
Extractor diameter	80 mm (3.15")	15610	Foldable lid		
Part.no. (standard unit)	DB22A DI22A (stainless steel)	8910	3-minute kit		
<i>(For extra features - please contact your local distributor or Hedson contact)</i>		10960	Collecting tray		

USER-FRIENDLY AND SUPERIOR CLEANING

Efficient and solvent saving manual clean rinse

The Drester Boxer Compact gun cleaners have a small footprint and are user-friendly with outstanding cleaning performance thanks to the Drester pump and the superior automatic wash compartment design. Can be used with solvent, water or water-borne solvent (Drester AquaSolve).

Drester Boxer Compact offer two models; DC11 automatic wash compartment with a manual clean rinse, DC 12 automatic wash compartment with a automatic and manual clean rinse.

- For solvent, water or water-borne solvent
- Fixed rinse nozzle fed with clean solvent
- Pneumatic extractor (Airvent) included



Boxer Compact 11 (DC11)



Boxer Compact 12 (DC12)

TECHNICAL DATA		
	DC11	DC12
Compressed air needed	7-12 bar (110-180 psi) 250 l/min (9 cfm)	7-12 bar (110-180 psi) 250 l/min (9 cfm)
Extraction capacity		
- with 15 m extension	140 m ³ /h (82 cfm)	140 m ³ /h (82 cfm)
- with 5 m extension	180 m ³ /h (106 cfm)	180 m ³ /h (106 cfm)
Weight	25 kg (55 lb)	29 kg (64 lb)
Overall dimensions		
- Height	1830 mm (72")	1830 mm (72")
- Width	590 mm (23")	590 mm (23")
Extractor diameter	80 mm (3.15")	80 mm (3.15")
Part.no. (standard unit)	DC11	DC12

(For extra features - please contact your local distributor or Hedson contact)

OPTIONS	
Part.no.	Description
15650	Magnetic gun holder
4020	Moisture trap
10455	Extension tube
15640	Kit for suction-fed gun
17270	Adapter for side-fed gun

CLEANING
BODY SHOP SOLUTIONS



SUPERIOR CLEANING TOOLS

Robust, compact and user-friendly manual gun cleaners with outstanding cleaning performance

The Drester Classics by Hedson have been on the market for decades, which says a lot about their performance and value for the money. They are still very high in demand and remain a reliable choice.

- Round sink with no welding seams for easy and convenient maintenance
- Manual wash with re-circulating solvent or recycled water
- Manual clean rinse so any residues can easily be detected

ROBUST AND USER-FRIENDLY

High performance gun cleaner for water-borne paint

Drester 1000 by Hedson has been dominating the water-borne cleaning market, and with its robustness and user friendliness it still has no equivalent. Beside its unequalled 35 litre/10 gallons capacity, it has a built-in waste recycling system, which saves money and the environment.

- Prepared for different set-ups depending on paint brand
- Foot operated for hands-free operation
- Automatic water evacuation



TECHNICAL DATA – DRESTER 1000	
Air consumption	100 l/min (4 cfm)
Flow through brush	1,5-2 l/min
Air supply	5-12 bar (80-180 psi)
Liquid volume of machine	35 l / 10 gallons
Weight	24 kg
Height	1220 mm (48")
Diameter	Ø 590 mm (23")
Part.no. (standard unit)	1000
<i>(For extra features - please contact your local distributor or Hedson contact)</i>	

OPTIONS	
Part.no.	Description
13136	Flow-through wash brush
R4466	Wash brush (3 pcs. of 13136)
8960	Mixer
8970	Flush gun
8980	Set up kit
8990	Wheel set
9520	Lid
9530	Door
4020	Moisture trap
9140	Cover plate

CONSUMABLES	
Part.no.	Description
230120	AquaSolve
9211	Flocculation powder
R8701	Main filter (5 pcs.)
R8702	Pre-filter (5 pcs.)

DESIGNED TO HANDLE WATER BASED PAINTS

Manual spray gun cleaner with brush and high pressure rinse gun

Water-borne paints are considerably harder to remove from spray guns than conventional paints. Therefore, the Drester 1050 by Hedson has been supplied with a pre-wash brush and a rinse gun fed with recycled water. It includes an air blow gun for drying after cleaning and a quick connect whip line for blowing out the spray gun paint channel.

It can also be equipped with a flush gun, enabling use with other rinsing water/solvent as often provided by the paint manufacturers.

- Low water consumption and recovery
- Powerful diaphragm pump
- Efficient filter system

TECHNICAL DATA	
Air consumption	100 l/min (4 cfm)
Flow through brush	1,5-2 l/min
Air supply	5-12 bar (80-180 psi)
Liquid volume of machine	35 l / 10 gallons
Weight	21 kg
Height	1050 mm (41")
Diameter	Ø 590 mm (23")
Part.no. (standard unit)	1050

(For extra features - please contact your local distributor or Hedson contact)

CONSUMABLES - 1050 & 2600	
Part.no.	Description
230120	AquaSolve
9211	Flocculation powder
R8701	Main filter (5 pcs.)
R8702	Pre-filter (5 pcs.)



CLEANING
BODY SHOP SOLUTIONS

EFFICIENT AND SOLVENT SAVING

The complete manual gun cleaner for efficient cleaning of spray guns and other tools

The Drester 2600 by Hedson has a wash brush which is fed with recirculating solvent and a nozzle in the lid for rinse with clean solvent.

Empty the paint channel through a funnel in the lid and dry it with an air gun which is fitted on the side of the machine. The Drester 2600 by Hedson is equipped with the unique Drester Teflon Diaphragm pump, specifically designed for use in gun cleaners. Automatic extraction protects the operator from hazardous fumes and improves the working environment.

- Manual cleaning with flow-through brush
- Foot operated for hands-free operation
- Manual clean rinse with venture nozzle

TECHNICAL DATA	
Air consumption	250 l/min (9 cfm)
Extraction capacity	
- 15 m extr. duct	140 m³/h (82 cfm)
- 5 m extr. duct	180 m³/h (106 cfm)
Air supply	5-12 bar (80-180 psi)
Liquid volume of machine	35 l / 10 gallons
Weight	30 kg
Height	990 mm (39")
Width	700 mm (27.5")
Part.no. (standard unit)	2600

(For extra features - please contact your local distributor or Hedson contact)

OPTIONS - 1050 & 2600	
Part.no.	Description
13136	Flow-through wash brush
R4466	Wash brush (3pcs. of 13136)
8970	Flush gun (1050)
8990	Wheel set (1050)
9520	Lid (1050)
9530	Door (1050)
4020	Moisture trap
8920	Hose extension kit (2600)
9140	Cover plate (2600)
10970	Flow-through wash brush (2600)



EFFICIENT CLEANING OF SPRAY GUNS

Automatic gun cleaner with manual clean rinse

Drester 3600 by Hedson cleans automatically with circulating thinner and has a manual rinse with clean thinner. During the wash cycle, air is blown through the spray gun's air channels to keep these free from solvent and fuzz.

Drester 3600 is easy to use and has an ergonomic design. The machine is air powered and can also be obtained in a two-gun model.

- Designed for use with conventional paints
- Automatic, highly efficient built-in extraction
- Equipped with air pressure regulator and water trap for durability

TECHNICAL DATA	
Air consumption	250l/min (9 cmf)
Extraction capacity	
- 15 m extr. duct	140 m ³ /h (82 cfm)
- 5 m extr. duct	180 m ³ /h (106 cfm)
Air supply	7-12 bar (110-180 psi)
Liquid volume of machine	depending on drum size
Weight	30 kg (67 lb)
Height	990 mm (39")
Width	700 mm (27.5")
Part.no. (standard unit)	3600
<i>(For extra features - please contact your local distributor or Hedson contact)</i>	

OPTIONS - 3600 & 8000	
Part.no.	Description
8910	3-minute kit
6642	Collecting tray (8000)
8501	Adaptor
8195	Base plate (8000)
8920	Hose extension kit
9290	2-gun spray cradle
10970	Flow-through wash brush
12129	Extension pipe 3m PPS



UNEQUALLED CLEANING RESULTS

Automatic gun cleaner with automatic and manual clean rinse

Drester 8000 by Hedson is an automatic gun cleaner designed for use with conventional or water based paints. The machine cleans automatically with a circulating solvent. Rinsing can be done either automatically or manually. During the wash cycle, air is blown through the spray gun's air channels to keep these free from solvent and fuzz.

The air powered machine is also available as a two-gun model.

- Designed for use with conventional or water-based paints
- Strong cleaning power and fully automatic
- Manual wash facility gives flexibility

TECHNICAL DATA – DRESTER 8000	
Air consumption	250l/min (9 c.f.m.)
Extraction capacity	
- 15 m extr. duct	140 m ³ /h (82 c.f.m.)
- 5 m extr. duct	180 m ³ /h (106 c.f.m.)
Air supply	7-12 bar (110-180 psi)
Liquid volume of machine	depending on drum size
Weight	33 kg (73lb)
Height	990 mm (39")
Width	700 mm (27.5")
Part.no. (standard unit)	8000-A 8000-B (with collecting tray base)
<i>(For extra features - please contact your local distributor or Hedson contact)</i>	



RELIABLE AND SUSTAINABLE

High-quality gun cleaners with excellent cleaning performance

The robust Drester X-series by Hedson are aimed towards workshops and industries with a heavy work load. The X-series features three models; one single with manual work station, one single with automatic work station and one double with two work stations, both manual and automatic.

- Welded stainless working platform
- Adjustable wash cycle, 1-4 min
- Spray Gun Storage, up to 7 gun storage
- Washes all types of guns - no limit to gravity fed guns
- Ergonomic with less depth



X-SERIES MANUAL BY HEDSON

A superior gun cleaner with a manual wash compartment for solvent based paint. Solvent flow is activated by a foot pedal. Equipped with a solvent brush and compressed air dryer.



X-SERIES AUTOMATIC BY HEDSON

Robust gun cleaner with a automatic wash compartment for solvent based paint. Equipped with timer and compressed air dryer.



X-SERIES DOUBLE BY HEDSON

Two compartments - automatic for cleaning of all types of solvent based paints, up to two guns at a time and manual or cleaning of primer and filler tools, scrapers etc. Equipped with timer, solvent brush and compressed air dryer.

TECHNICAL DATA			OPTIONS	
	Manual/Automatic	Double	Part.no.	Description
Compressed air needed	7-12 bar (110-180 psi) 90 l/min. (3 cfm) 1 pump 370 l/min (14 cfm) incl. AIRVENT 11660 in operation	7-12 bar (110-180 psi) 180 l/min. (6 cfm) 2 pumps 460 l/min (17 cfm) incl. AIRVENT 11660 in operation	2050	Minivent (3ph. 380V, 250W) (DIX22)
Ventilation capacity required	500 m³/h (310 cfm)	600 m³/h (380 cfm)	2055	Minivent (3ph. 415V, 250W) (DIX22)
Pump capacity	10 l/min	10 l/min	11660	Airvent (Ø125 mm)
Maximum drum size	60 litres	60 litres	15650	Magnetic gun holder
Solvent pressure	2 bar (30 psi)	2 bar (30 psi)	9290	2-gun spray cradle
Weight	75 kg (165 lb)	95 kg (209 lb)	10960	Collecting tray
Overall dimensions			4020	Moisture trap
- Height	1510 mm (59.5")	1510 mm (59.5")	10455	Extension tube
- Width	835 mm (33")	1185 mm (46.7")	15640	Kit for suction-fed gun
- Max depth	650 mm (25.5")	650 mm (25.5")	17270	Adapter for side-fed gun
- Depth at the floor	610 mm (24")	610 mm (24")		
Extractor diameter	125 mm (5")	125 mm (5")		
Part.no. (standard unit)	DIX11M/ DIX11	DIX22		

QUICK AND EASY CLEANING

Efficient and user friendly pneumatic rinsing gun cleaner for use with disposable cup systems

The Drester QuickRinse by Hedson has been developed to provide quick, thorough spray gun cleaning for water or solvent paints, especially for use with disposable cup system.

It can be easily installed anywhere in the paint shop, including inside the paint booth when used as a water-borne cleaner. Installation is simple and easy, either with the use of magnets for attachment to the booth or mixing room walls or more permanently with zip screws. Save time by keeping the gun cleaner close to the paint job.

- For all disposable cup system
- Perfectly clean spray gun in 10 seconds gives time and cost savings
- High-pressure cleaning for safe colour changes

DRESTER QR-10

The Drester QR-10 is a manual gun cleaner for water-borne paints and is equipped with the well-proven diaphragm pump to allow for proper flow and pressure. Drester QR-10 can be placed inside the spray booth.

DRESTER QR-20

The Drester QR-20 is a manual gun cleaner for solvent based paints.

DRESTER QR-TT

The Drester QR-TT is a manual gun cleaner for both water-borne and solvent based paints. If water-borne solvents are used it can be placed inside the spray booth.



QR-10



QR-20



QR-TT

TECHNICAL DATA			
Compressed air needed	5-12 bar (80-180 psi), 100 l/min (4 cfm)	5-12 bar (80-180 psi), 100 l/min (4 cfm)	5-12 bar (80-180 psi), 100 l/min (4 cfm)
Pump capacity	2 l/min	2 l/min	2 l/min
Permitted solvents	Water or water-based solvents	Solvent and solvent mixtures	LEFT BOX: Water or water-based solvents RIGHT BOX: Solvents and solvent mixtures
Liquid volume of machine	5 + 5 litre	Amount of wash fluid depending on chosen size of container	3 l/solvent (amount of water depending on chosen size of container)
Overall dimensions			
- Height	645 mm (25.5")	461 mm (18.1")	667 mm (26.3")
- Width	535 mm (21.0")	306 mm (12.1")	565 mm (22.2")
- Depth	263 mm (10.5")	273 mm (10.8")	264 mm (10.4")
Part.no. (standard unit)	QR-10	QR-20	QR-TT

(For extra features - please contact your local distributor or Hedson contact)

OPTIONS	
Part.no.	Description
2050	Minivent (3ph. 380V, 250W)
2055	Minivent (3ph. 415V, 250W)
1294	Minivent (1ph. 230V, 250W)
10960	Collecting tray
4020	Moisture trap
14010	Airvent (Ø80 mm)
14231-A	Brush
14310	Hose extension kit (QR-10)
15130	Elbow and collar (QR-20, QR-TT)
15140	Airvent (QR-20, QR-TT)
15220	Hose extension kit (QR-TT)



DRESTER GUN CLEANER EQUIPMENTS

Better, flexible and safer cleaning performance with additional equipment's from Drester by Hedson

EFFICIENT AND SMART SOLUTIONS

Keep the mixing room structured for a more efficient workflow with the practical mixing table from Drester by Hedson

The mixing tables are adapted in color and shape to the Drester by Hedson gun cleaner and Waste Management product range for a smart homogeneous look in the mixing room.

- Smart storage which gives efficient work flow
- Basic model with one shelf underneath fits every work shop
- Available in powder coated or stainless finish



TECHNICAL DATA		OPTIONS FOR MT-120	
Airvent diameters		Part.no.	Description
14010	Ø100 mm	2050	Minivent (3ph. 380V, 250W)
14020/14040	Ø125 mm	2055	Minivent (3ph. 415V, 250W)
Weight		1294	Minivent (1ph. 230V, 250W)
- Basic model	30 kg	11660	Airvent (Ø125 mm)
- With slot extraction and airvent	36,5 kg	15650	Magnetic gun holder
- With hood and airvent	45 kg	10187	Flange
Width	1200 mm	13440	Airvent kit
Height		17360	Hood
- Basic model	930 mm	14040	Airvent (unit for 17360)
- With slot extraction	1110 mm	13970	Slot extraction (for 14010)
- With hood	1470 mm	14010	Airvent (Ø80 mm)
- Working height	905 mm	13930	Shelf, extra
Max depth	565 mm	14030	Side shelf
Part.no. (standard unit)	MT-120 (powder coated)		
<i>(For extra features - please contact your local distributor or Hedson contact)</i>			

REDUCE SOLVENT CONSUMPTION

Better gun cleaning performance with an environmentally friendly closed system of handling solvents

A unique and closed system of handling solvents, consists of a recycler, docking unit and a Drester solvent or combo gun cleaner.

The transfer of the solvents between the gun cleaner and the recycler is fully automated; the dirty, heavy and hazardous manual solvent handling is eliminated and at the same time the equipment and floor in the workshop stays clean. Instantly after the transfer of solvents, access to clean solvent in the gun cleaner is available.

The system allows for the units to be placed either close together or in separate rooms up to 25 meters (subject to local fire legislation).

The convenient operation of the Drester Dynamic Triple by Hedson system encourages to run the system often. This keeps the solvent in the gun cleaner in better condition,

resulting in improved gun cleaning performance. The consumption of solvent is reduced, the waste of solvent is kept to a minimum and costs are cut dramatically.

- Reduce the solvent consumption to save money and the environment
- Keep the spray guns cleaner and speed up the workflow



DRESTER RDX - DOCKING UNIT

Convenient solvent transfer

The Drester RDX is a docking unit in the Drester Dynamic Triple with an overflow protection. For space saving in the workshop, the docking unit can be placed inside the gun cleaners of the Drester Boxer series.

TECHNICAL DATA - DOCKING UNIT	
Compressed air needed	Clean, dry air at 3-10 bar
Solvent capacity	Max. 80 litres
Pump capacity	10 l/minutes
Liquid pressure	2 bar
Weight	21 kg
Height	700 mm (17,5")
Diameter	500 mm (19,5")
Part.no. (standard unit)	RDX-8012 (Drester 2600,3600 & 8000) RDX-9012 (Drester Boxer Aqua, Solvent)

(For extra features - please contact your local distributor or Hedson contact)



DRESTER 120 - RECYCLER

Recovers and recycles the solvent used in the gun cleaner

The Drester 120 is a solvent recycler in the Drester Dynamic Triple and is a well proven product sold in vast numbers worldwide. The recycler can also be used as a stand-alone product.

CONSUMABLES - RECYCLER	
Part.no.	Description
11061	Recycle Bag - for waste handling
Delivered in 50 pcs	



Recycle Bag

TECHNICAL DATA - RECYCLER	
Type of solvents distillable	Thinner type
Boiler capacity	12 litres
Residues discharge	Plastic bag
Condensation system	By air
Condensate material	Stainless steel
Time/cycle	3-4 hours
Voltage	200-240 V single Phase 50 or 60Hz
Electrical construction	Explosion proof
Dimensions	- Width 590 mm (23") - Height 1610 mm (63") - Max depth 120 mm (47")
Weight	67 kg
Part.no. (standard unit)	DR-120-A

(For extra features - please contact your local distributor or Hedson contact)

IMPROVE THE WORK ENVIRONMENT

Improves the work environment and collect the paint waste in a safe and efficient way

Keep a safe and clean work environment with the simple and smart solution with Drester Waste Management by Hedson.

The waste management improves your environment and gets rid of paint residues and other waste in a safe and efficient way in compliance with all applicable European directives and standards.

The Drester Waste Management by Hedson comes in three different models: one for liquid waste, one for solid waste and one model combining the two. Each model has two compartments, so you can easily separate two different types of waste, for example waterborne paints from solvent borne. The waste is collected in drums underneath.

- Two compartments for easy separation of waste
- Equipped with two funnels with grids, for cans to be left to drain
- Flexible usage - extraction can be connected either directly or through a hood



CLEANING
BODY SHOP SOLUTIONS

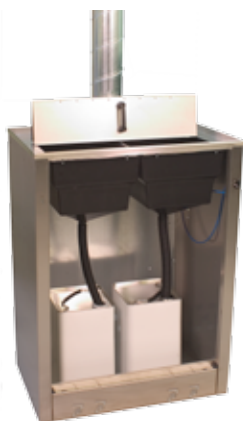

DRESTER WM-90-1
Two compartments for liquid waste



DRESTER WM-90-2
One compartment for liquid and one for solid waste



DRESTER WM-90-3
Two compartments for solid waste

TECHNICAL DATA		OPTIONS	
Compressed air needed	7-12 bar (110-180 psi) 450 l/min (16 cfm) (if extraction is desired)	Part.no.	Description
Weight	42 kg	2050	Minivent (3ph. 380V, 250W)
Width	780 mm (31")	2055	Minivent (3ph. 415V, 250W)
Height	1025 mm (40") - Standard 1470 mm (58") - With hood 2230 mm (89") - With hood and airvent	1294	Minivent (1ph. 230V, 250W)
Depth at the floor	570 mm (23")	11660	Airvent (Ø125 mm)
Extractor flange diameter	125 mm (5") with flange part.no. 10187	15650	Magnetic gun holder
Part.no. (standard unit)	WM-90-1 WM-90-2 WM-90-3	10960	Collecting tray
<i>(For extra features - please contact your local distributor or Hedson contact)</i>		17350	Hood
		10187	Flange
		1440	Airvent kit
		13657	Stand
		R13490	Waste box (w. drain hose)
		13666	Waste box (open bottom)
		13370	Drain Hose
		13401	Working platform
		14030	Side shelf

DRESTER CONSUMABLES

Drester consumables for gun cleaners has the same outstanding quality and high standard, just like the gun cleaners

AQUASOLVE - WATER-BORNE SOLVENT

Better cleaning performance and more friendly for the environment, now with a new formula

When cleaning automatically, a water-borne solvent is necessary, since dried water-borne paint will not dissolve with only water. Drester AquaSolve by Hedson can be used with both automatic and manual gun cleaners and it keeps its excellent cleaning power even when used for several weeks.

With a proper gun cleaner, the main cleaning is done with re-circulating Drester AquaSolve by Hedson and only a very minor amount of fresh solvent is spent per gun. The Drester AquaSolve by Hedson can be coagulated and filtered, thereby saving the user from expensive waste collection. After cleaning with solvents, clean rinse with water.

- Anti-corrosion additives which protect both aluminium and brass, both in spray gun and gun cleaner
- Works with all paint brands
- Complies with the REACH directive
- Easy to ship, non-dangerous goods
- Long lasting - mix 1 bottle (1 l) with 10 litre water



DRESTER FILTERS

For better cleaning performance

The filters from Drester by Hedson have been tested and approved by the paint manufactures. The flocculated paint sludge is caught in a primary filter (pre-filter). For better performance, there is also a fine filter (main filter) which will trap even the tiniest particles.

The filters are kept above the water to avoid mould and discolouring. Both filters can be reused several times.



FLOCCULATION POWDER

Efficient cleaning of the waste water

Automatic agitation of the dirt water with pulsating air or a mixer ensures perfect flocculation in a matter of minutes. The round shape of the wash basin facilitates the flocculation and the cleaning afterwards.

AQUASOLVE	
Part.no.	230120 Delivered in 1 L x 12 pcs
TO BE USED IN FOLLOWING DRESTER GUN CLEANERS	
Part.no.	Description
DB22A	Drester Boxer Aqua
DB22C	Drester Boxer Double Combo
DB33C	Drester Boxer Triple Combo
DB44C	Drester Boxer Quattro Combo
1000	Drester Classics 1000
1050	Drester Classics 1050
QR-10	Drester QuickRinse, water
QR-TT	Drester QuickRinse, water & solvent

FILTERS	
Part.no.	R8701 - Main filter (<i>standard</i>) R8702 - Pre-filter (<i>always to be used</i>) Delivered in 5 pcs.
TO BE USED IN FOLLOWING DRESTER GUN CLEANERS	
Part.no.	Description
DB22A	Drester Boxer Aqua
DB22C	Drester Boxer Double Combo
DB33C	Drester Boxer Triple Combo
DB44C	Drester Boxer Quattro Combo
1000	Drester Classics 1000
1050	Drester Classics 1050
QR-10	Drester QuickRinse, water
QR-TT	Drester QuickRinse, water & solvent

FLOCCULATION POWDER	
Part.no.	9211 Delivered in can / 1,5 kg.
TO BE USED IN FOLLOWING DRESTER GUN CLEANERS	
Part.no.	Description
DB22A	Drester Boxer Aqua
DB22C	Drester Boxer Double Combo
DB33C	Drester Boxer Triple Combo
DB44C	Drester Boxer Quattro Combo
1000	Drester Classics 1000
1050	Drester Classics 1050

DRESTER BOXER BY HEDSON

Basic features

	SOLVENT		AQUA	COMBO			COMPACT	
	DB22S	DB44S	DB22A	DB22C	DB33C	DB44C	DC11	DC12
Unique magnetic gun holder, patent approved	●	●	●	●	●	●	●	●
Hands-free operation, foot-pedal operated	●	●	●	●	●	●	●	●
Optimized placements of nozzles, for superior cleaning	●	●	●	●	●	●	●	●
Funnel for blow-out	●	●	●	●	●	●	●	●
Air gun for drying	●	●	●	●	●	●	●	●
Air supply line	●	●	●	●	●	●	●	●
3-year pump warranty	●	●	●	●	●	●	●	●
Available with stainless cabinet	●	●	●	●	●	●	●	●
ATEX category	2	2	2	2	2	2	2	2
Automatic cleaning with re-circulating solvent	●	●		●	●	●	●*	●
Automatic rinsing with clean solvent	●	●			●	●		●
Automatic cleaning with re-circulating water-borne solution			●			●	●*	
Automatic rinsing with clean water			●			●		
Flow-through brush fed with re-circulating solvent	●	●			●	●		
Flow-through brush fed with re-circulating water-borne solution			●	●	●	●		
Hand-held rinse nozzle fed with clean solvent	●	●			●	●		
Fixed rinse nozzle fed with clean solvent				●			●	●
Hand-held rinse nozzle fed with clean water			●	●	●	●		
Pneumatic extractor (Airvent) included			●	●			●	●
Extraction hood; use Airvent, Minivent or central extraction	●	●			●	●		
No. of pumps	2	4	2	2	3	4	1	2
Can be connected to Drester recycler through a Docking unit (RDX)	●	●		●**	●	●	●	●
Rinse gun for high pressure water cleaning of paint channels			●	●	●	●		
Rinse gun can be set up to be fed with recycled water or tap water			●			●		
Optional tap water kit, to feed tap water through rinse gun				●	●			
Automatic agitation when flocculating			●	●	●	●		
Dual filter system for unsurpassed efficiency when recycling water			●	●	●	●		
Automatic evacuation of filtrate container			●			●		

* DC11 can be used for automatic cleaning with either solvent or waterborne solvent, such as Drester AquaSolve

** RDX must be placed outside of the cabinet

DRESTER CLASSICS BY HEDSON

Basic features

	1050	1000	2600	3600	8000
Manual wash with re-circulating solvent/recycled water	●	●	●		
Manual clean rinse	●	●	●	●	●
Air connection and funnel for spray out			●	●	●
Air gun for drying spray gun	●		●		
Extraction unit (Airvent) included			●	●	●
Number of pumps	1	1	1	1	2
3-year warranty on diaphragm pumps	●	●	●	●	●
Can be connected to Drester 120 with the Docking Unit RDX			●	●	●
Can be used with water borne paints	●	●			●
Specifically adapted for all water borne paint systems	●	●			
Cleaning brush	●	●	●		
Rinse gun with nozzle for high pressure cleaning of paint channel	●	●			
Automatic agitation during flocculation	●	●			
Dual filter system for separation of paint sludge	●	●			
Automatic evacuation of filtrate container		●			
Nozzle for quick cleaning of paint channels			●		
ATEX category	3	3	2	2	2

AIR SUPPLY HOSE

Flexible air connection to connect the gun for spray-out purposes.

AUTO AND MANUAL SIMULTANEOUSLY

The Boxer units enable automatic and manual cleaning simultaneously. Use the spacious manual sink at any time. No more waiting for the automatic cleaning to finish.

BOXER PERFORMANCE

Equipped with an Auto box, with spray patterns and nozzles tuned for superior cleaning performance.

BRUSH

It is harder to remove water-borne paints than solvent-based paints. That is why Drester aqua cleaners are fitted with a flow-through brush, which is fed with recycled water. All Boxer units are fitted with a brush and for the others it is available as an accessory.

CLEAN - RINSE - DRY

Recirculating AquaSolve cleans water guns extremely efficiently, and is then rinsed of with only a small amount of clean water, keeping consumption to a minimum.

DOUBLE FILTER SYSTEM

35 litre filters means that you can dump the whole batch at once. The flocculated paint sludge is caught in a primary filter. For better performance there is also a main filter which will trap even the finest particles. The filters

are kept above the water to avoid mould and discolouring. Both filters can be reused several times.

EVACUATION

After filtration, the water can be reused or pumped into a drum or into the drain (subject to local approval).

No heavy lifting necessary.

FLOCCULATION

Automatic agitation of the dirt water with pulsating air or a mixer ensures perfect flocculation in a matter of minutes. The round shape of the wash basin facilitates the flocculation and the cleaning afterwards.

HANDS FREE

Foot-operated pumps for hands-free operation.

HOOD/EXTRACTION

The hood protects from splashing and enables different types of ventilation: Drester Airvent, Drester Minivent or central ventilation.

MANUAL WASH WITH RE-CIRCULATING SOLVENT

Flow-through brush with re-circulating solvent for manual washing of the gun and other items.

PUMPS FOR AUTOMATIC WASH AND CLEAN RINSE

The powerful Teflon diaphragm pumps feed the nozzles with solvent. To reduce solvent consumption, the pump for clean solvent is working only as long as the operator is pressing the pedal.

RINSE GUN

The rinse gun's nozzle is designed specifically for high pressure cleaning of the spray gun paint channel when using water-borne paints.

RINSE WITH CLEAN SOLVENT

Access to fresh solvent for clean rinse of guns and other items. A mix of air and solvent cleans efficiently and reduces solvent consumption.

SPRAY NOZZLES

Specifically designed spray nozzles to give an optimal wash power with its even and broad spray pattern. Easy to maintain and clean.

SWEDISH STEEL

Available in epoxy powder-coated steel or in stainless steel.

TIMER

The reliable timer controls the time of the automatic wash cycle.

VAPOR RECOVERY

When spraying out the gun, the vapors are collected and condensed in the collecting spray-out funnel.

WATER TRAP AND PRESSURE REGULATOR

Equipped with air pressure regulator and water trap for durability.



HERKULES LIFTS BY HEDSON

Ergonomic lifts with superior compact construction to meet the high demands in the workshop

Thanks to extensive market experience, innovative technology and creative product design, Herkules by Hedson can offer safe and durable lifts that meet even the toughest market demands.

In the workshop, it is important that the environment is clean and explosion proof. All Hedson lifts use pneumatic lifting technology, which means they are driven by compressed air, no electrical connection is required. In the workshops air supply is common and provides a clean, dependable and almost maintenance free operation.

Nearly 85 % of all car damages require the worker to work in a stooped position. This causes fatigue and can also lead to

long-term health problems. With a lift the work can be done in an ergonomically correct upright position, which also increases the work efficiency and improves the quality by better visual control opportunities.

- Pneumatic lifting technology
- High stability
- Silicone free (PWIS-free, stands for paint-wetting impairment substances)
- Stepless lifting heights

SIMPLIFIES AND IMPROVES THE QUALITY

The perfect lift for all types of body and paint shops

The lifting and lowering of the working height is done safely and smoothly with a Herkules HLS 1200 by Hedson and increases the access to damaged areas and the ergonomic work process.

This lift is available in three types for different demands - on-ground, flush mounted and rail transportation. The lifts are easy to install and facilitate an individual planning of body shops by using the existing space optimally.

Due to the low construction height, it is easy to drive the vehicles onto the lift. The work efficiency is increased and the quality is improved by better visual control opportunities due to the easy lifting.

- 2.5 tons lifting capacity
- Wheel supported
- Simple access with drive over ramps and deviate loading ramps
- On-ground, flush mounted or rail transport installations



ON-GROUND

Simply fix with screws and dowels, and the lift is ready for immediate use.



FLUSH MOUNTED

Flush mounted to concrete or grids.



RAIL TRANSPORT

Lift for rail transport.

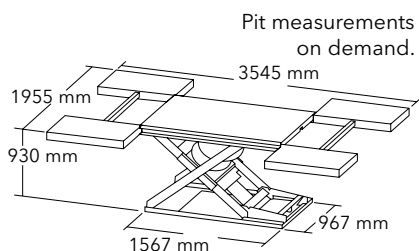

TECHNICAL DATA					CONSUMABLES	
Loading capacity	2.5 tons	Weight	750 kg		Part.no.	Description
Air supply	6 bar	Lifting height	930 mm		700-259	Filter control system 1/2"
Part.no.	Working height	Object height only	Pit depth	Installation	300-380	Grids frame with grids, zinc coated
HLS 1200-11	~1100 mm	110 mm	-	On-ground	300-305	Fitting frame (grids), primed
HLS 1200-13	~1100 mm	135 mm	-	Rail transport	300-304	Fitting frame (grids), zinc coated
HLS 1200-14	~1000 mm	-	115 mm	Flush mounted	300-306	Fitting frame (concrete), primed
HLS 1200-16	~1000 mm	-	115 mm	Flush mounted with CE-Stop	300-307	Fitting frame (concrete), zinc coated
HLS 1200-17	~1100 mm	110 mm	-	Transmobile		
HLS 1200-18	~1100 mm	110 mm	-	Transmobile with drive over ramps (4 pcs)		

LIFT WITH A COMPACT CONSTRUCTION

The paint- and body shop lift with increased lifting height

The intelligent construction with the innovative extras and the extended lifting height makes the Herkules HLS 1600 by Hedson the perfect professional lift for future-oriented paint shops.

Thanks to its compact construction, the lift is also suited for smaller workshops. Due to its fold down driving tracks and a drive-on ramp, which is level with the rest of the lift, working with the Herkules HLS 1600 is easier than working with many other lift types.

Further the ergonomic work and the good visual control opportunities increase the efficiency and ensure the health of the employees.

Herkules HLS 1600 also offers a model with immersed possibilities, which allows the lowering of the vehicle in the booth ground for easy work on the roof area of the vehicle - perfect for high vehicles such as SUVs and vans.

- 3 tons lifting capacity
- Wheel supported
- Extended lifting height
- On-ground, flush mounted or immersible installations



ON-GROUND

Ready for immediate use. Easily accessible due to the ramps.



FLUSH MOUNTED

Flush mounted to concrete or grids. Ideal for new installation sites.

LIFTING BODY SHOP SOLUTIONS

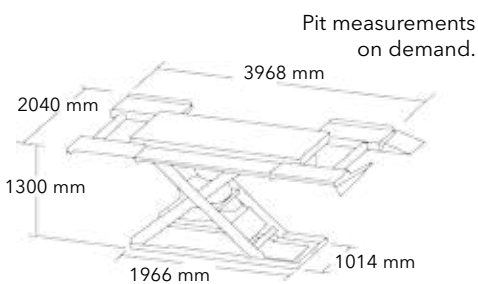

For wheel bases up to 3500 mm

1300 mm Lifting height

TECHNICAL DATA						
Loading capacity	3 tons					
Air supply	6 bar					
Part.no.	Weight	Lifting height	Working height	Object height only	Pit depth	Installation
HLS 1600-11	800 kg	1300 mm	~1600 mm	160 mm	-	On-ground
HLS 1600-14	800 kg	1150 mm	~1400 mm	-	160 mm	Flush mounted
HLS 1600-16	800 kg	1150 mm	~1400 mm	-	160 mm	Flush mounted with CE-Stop

CONSUMABLES	
Part.no.	Description
700-259	Filter control system 1/2"
300-309	Protection frame (grids), primed
300-308	Protection frame (grids), zinc coated
300-310	Protection frame (concrete), primed
300-311	Protection frame (concrete), zinc coated

EXCEPTIONAL FOR HEAVY VEHICLES

Smooth and safe lifting for an ergonomic work process

The Herkules HLS 3200 by Hedson - with a loading capacity of 3.2 tons - is constructed for heavy vehicles. This creates a safe work environment and provides the possibility also for SUVs and small vans.

The lift is also equipped with an extended platform, which also allows lifting for extended vehicles. The smooth lifting increases the access to damaged areas and the ergonomic work process.

- 3.2 tons lifting capacity
- Wheel supported
- Extended platform
- On-ground or flush mounted installations



ON-GROUND

Ready for immediate use. Easily accessible due to the ramps.



FLUSH MOUNTED

Flush mounted to concrete or grids. Ideal for new installation sites.

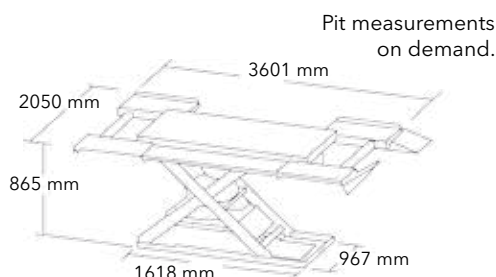

TECHNICAL DATA					CONSUMABLES	
Loading capacity	3.2 tons	Weight	850 kg		Part.no.	Description
Air supply	6 bar	Lifting height	Variable to strain		700-259	Filter control system 1/2"
Part.no.	Working height	Object height only	Pit depth	Installation	300-380	Grids frame with grids, zinc coated
HLS 3200-11	~ 1050 mm	122 mm	-	On-ground	300-371	Fitting frame (grids), zinc coated
HLS 3200-14	~950 mm	-	130 mm	Flush mounted	300-372	Fitting frame (grids), primed
HLS 3200-16	~950 mm	-	130 mm	Flush mounted with CE-Stop	300-373	Fitting frame (concrete), primed
HLS 3200-17	~ 1050 mm	122 mm	-	Transmobile	300-374	Fitting frame (concrete), zinc coated
HLS 3200-18	~ 1050 mm	122 mm	-	Transmobile with drive over ramps (4 pcs)		



HERKULES LIFTS - DUO

Two lift systems - perfectly combined

The Herkules by Hedson DUO lifts are one lift with two possibilities. The vehicles can be either lifted on wheels or underneath the vehicles for wheel free work.

The DUO lifts have the same features as all Hedson lifts, such as deviated loading ramps to make the access to the panel easier, stepless lifting height to secure the ergonomic work process and loading ramps to secure the vehicle against falling.

- Lifting on the wheels or wheel free lift
- Ergonomic work process
- Easily to drive-on, due to ramps
- On-ground or flush mounted installations

ONE LIFT - TWO POSSIBILITIES

Outstanding lift with double operation

The Herkules HLS 1200 DUO by Hedson is a user-friendly lift for workshops who need to lift the vehicles either on wheels or for a wheel free work position.

- 2.5 tons lifting capacity
- Lifting on the wheels or wheel free lift
- On-ground or flush mounted installations



ON-GROUND

Simply fix with screws and dowels, and the lift is ready for immediate use.



FLUSH MOUNTED

Flush mounted to concrete or grids.

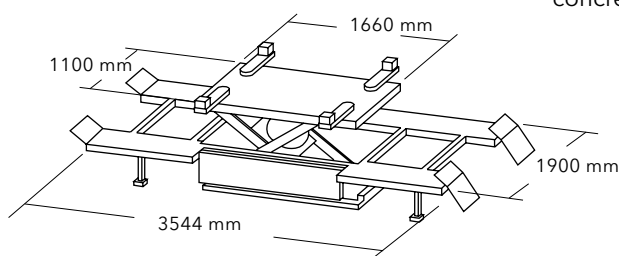

TECHNICAL DATA							CONSUMABLES	
Loading capacity	2.5 tons	Weight	850 kg				Part.no.	Description
Air supply	6 bar						310-021 Filter control system 1/2"	
Part.no.	Lifting height	Working height	Object height only	Construction height with arms	Pit depth	Installation	300-324 Fitting frame (grids), primed	
HLS 1200-DUO-11	max. 930 mm	~1100 mm	110 mm	155 mm	-	On-ground	300-323 Fitting frame (grids), zinc coated	
HLS 1200-DUO-14	max. 825 mm	~1000 mm	-	-	115 mm	Flush mounted	300-325 Fitting frame (concrete), primed	
HLS 1200-DUO-17	max. 930 mm	~1100 mm	110 mm	155 mm	-	Transmobile	300-326 Fitting frame (concrete), zinc coated	
HLS 1200-DUO-18	max. 930 mm	~1100 mm	110 mm	155 mm	-	Transmobile with drive over ramps (4 pcs)		

INCREASED LIFTING POWER

Lift with double functionality for a multifunction workplace

With 3.2 tons loading capacity and the extended platform size the Herkules 3200 DUO by Hedson is also suitable for heavy vehicles and small vans. The drive on ramps are adjustable in four positions and removable to adapt the lift to the required wheel base (only on-ground version).

- 3.2 tons lifting capacity
- With removable ramps, easily load or unload vehicles
- On-ground and flush mounted

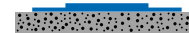

ON-GROUND

Simply fix with screws and dowels, and the lift is ready for immediate use.



FLUSH MOUNTED

Flush mounted to concrete or grids.

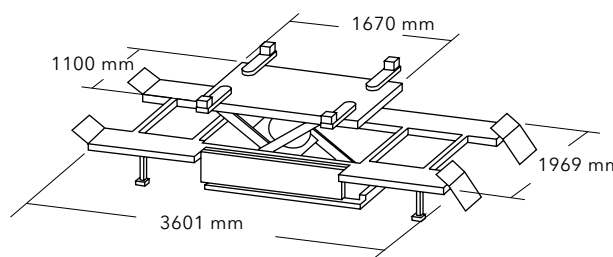

ALTERNATIVELY



TECHNICAL DATA					
Loading capacity	3.2 tons	Weight	850 kg		
Air supply	6 bar	Lifting height	Variable to strain		
Part.no.	Working height	Object height only	Construction height with arms	Pit depth	Installation
HLS 3200-DUO-11	~ 1050 mm	120 mm	170 mm	-	On-ground
HLS 3200-DUO-14	~ 950 mm	-	-	130 mm	Flush mounted
HLS 3200-DUO-17	~ 1050 mm	120 mm	170 mm	-	Transmobile
HLS 3200-DUO-18	~ 1050 mm	120 mm	170 mm	-	Transmobile with drive over ramps (4 pcs)

CONSUMABLES	
Part.no.	Description
700-259	Filter control system 1/2"
300-380	Grids frame with grids, zinc coated
300-371	Fitting frame (grids), zinc coated
300-372	Fitting frame (grids), primed
300-373	Fitting frame (concrete), primed
300-374	Fitting frame (concrete), zinc coated



SAFE LIFTING WITH TROLLEYS

Herkules HLQ by Hedson is a drive-over lift with trolleys for side transportation

The Herkules HLQ by Hedson is a perfect solution for spray booths equipped with trolleys for side transportation.

While lifted, even the lower parts of the car can be reached comfortably. This increases the work efficiency and improves the quality.

The vehicle is safely lifted on its wheels and when the lift is lowered, the trolleys are guided into the rails. The vehicle can then easily be pushed sideways into the spray booth.

- Lifting on the wheels
- Vehicle can easily be pushed sideways
- Smooth lifting
- Flush mounted installations

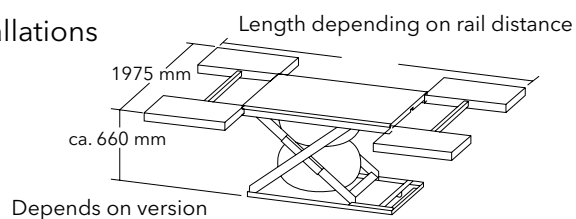

FLUSH MOUNTED

Flush mounted into the grid with adjustment of the rails.

TECHNICAL DATA	
Loading capacity	2.5 tons
Air supply	6 bar
Weight	500 kg
Working height	~ 800 mm
Installation	Flush mounted It's prepared for installation into grids with adjustment to the existing rails.
Part.no.	HLQ 01

FLEXIBLE AND SPACE SAVING LIFT

With the lifts, horizontal moveable swivel arms, it is easy to reach the vehicles' original lifting points

With a Herkules HM 1100 by Hedson lift there is no installation necessary in the work shop, the lift is ready to use immediately. And with an additional set of wheels and pole handle (optional) it is mobile in the shop.

The lift is equipped with swivel arms which easily reach the vehicles' original lifting points. The radius of the swivel arms also allows for a safe fixing of wide vehicles.

- 2.8 tons lifting capacity
- Fast lifting
- Small space requirements
- On-ground or flush mounted installations

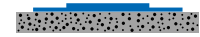

ON-GROUND

Simply fix with screws and dowels, and the lift is ready for immediate use.



FLUSH MOUNTED

Flush mounted to concrete or grids.

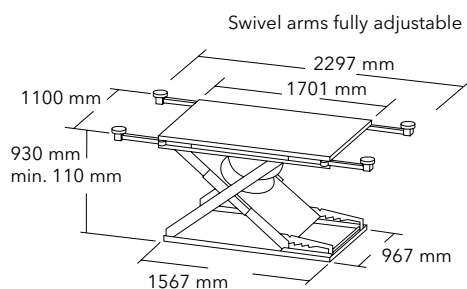

CONSUMABLES - RUBBER BLOCKS	
Part.no.	Description
800-108	220x130x120 mm for RS lift
800-107	120x120x100 mm for Multi lift
800-105	120x100x80 mm Standard
800-106	220x130x120 mm for Multi lift
800-112	160x140x110 mm for VW bus, Transporter
800-104	120x100x30 mm for DB

TECHNICAL DATA					
Loading capacity	2.8 tons	Weight	510 kg		
Air supply	6 bar				
Part.no.	Working height	Object height	Lifting height	Pit depth	Installation
HM 1100-01	~ 1100 mm	115 mm	930 mm	-	On-ground
HM 1100-04	~ 1000 mm	-	825 mm	115 mm	Flush mounted, with 4 rubber blocks 800-105

CONSUMABLES	
Part.no.	Description
300-170HM	Handle and wheels for HM lift
300-317	Fitting frame (HM 1100-04), primed
300-318	Fitting frame (HM 1100-04), zinc coated



BETTER WORKSHOP UTILIZATION

Move the vehicles through tight spaces in the workshop safe and easy

Herkules Transmobile by Hedson is the revolutionary system for modern workshops. It creates new working capacity due to a safer and quicker work routine and drastically reduces the work involved in vehicle transportation around the workshop.

The vehicles are on lifts from the moment the work is started right through to the final inspections and can safely and quickly be moved to subsequent workstations.

The transportation system consists of the remote controlled automotive transmobile, and a Herkules by Hedson lift. It can be used in any shop with a level surface, even in the spray booth with grid floor.

- Lower wage costs
- Reduces vehicle transportation times
- Powerful self-drive with no harmful exhaust gases

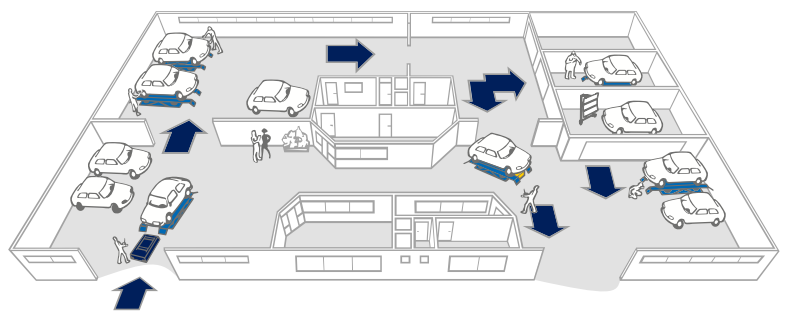

TECHNICAL DATA		
Loading capacity	2.5 tons	3.2 tons
Weight	560 kg	600 kg
Drive	24 V	24 V
Remote control	Yes	Yes
Part.no.	HLT 03	HLT 04
CONSUMABLES		
Part.no.	Description	
400-218	Programming console for Transmobile	
300-247	Trolley for crosswise moving Transmobile	

LIFTS FOR TRANSMOBILE	
Part.no.	Description
HLS 1200-17	2.5 tons lift
HLS 1200-18	2.5 tons lift with drive over ramps (4 pcs)
HLS 3200-17	3.2 tons lift
HLS 3200-18	3.2 tons lift with drive over ramps (4 pcs)
HLS 1200-DUO-17	2.5 tons DUO lift
HLS 1200-DUO-18	2.5 tons DUO lift with drive over ramps (4 pcs)
HLS 3200-DUO-17	3.2 tons DUO lift
HLS 3200-DUO-18	3.2 tons DUO lift with drive over ramps (4 pcs)

HERKULES LIFTS BY HEDSON

Basic features

	HLS 1200-11	HLS 1200-14	HLS 1600-11	HLS 1600-14	HLS 3200-11	HLS 3200-14	HLS 1200-DUO-11	HLS 1200-DUO-14	HLS 3200-DUO-11	HLS 3200-DUO-14	HLQ 01	HM 1100-01	HM 1100-04
SCOPE OF DUTIES													
Paint- and body work	●	●	●	●	●	●	●	●	●	●	●	●	●
Tirework							●	●	●	●		●	●
DRIVING SPECIFICATIONS													
Over ramps 4 pieces		●		●		●		●		●			
Over ramps 2 pieces	●		●		●		●		●				
Drive through possibility	(●)	●	(●)	●	(●)	●	(●)	●	(●)	●		●	
LIFTING SPECIFICATIONS													
Chassis supported							●	●	●	●		●	●
Wheel supported	●	●	●	●	●	●	●	●	●	●	●		
TECHNICAL SPECIFICATIONS													
Lifting Capacity (tons)	2,5	2,5	3	3	3,2	3,2	2,5	2,5	3,2	3,2	2,5	2,8	2,8
Object height (cm)	11	11	15	11	12	12	11	11	12	12	10	11	11
Working height (cm)	110	110	160	145	max. 105	max. 95	110	100	max. 105	max. 95	80	110	110
Net lifting height (cm)	82	82	115	115	max. 77	max. 77	82	82	max. 77	max. 77	64	82	82
Air supply (max. bar)	8	8	8	8	8	8	8	8	8	8	8	8	8
INSTALLATION SPECIFICATIONS													
Flush Mounted		●		●		●		●		●	●		●
On Ground	●		●		●		●		●			●	
Mobile												(●)	
Rail											●		

Standard ● Optional (●)

THE WORKING LIFT FOR THE PAINTER

Safe lifting for all kind of works around the vehicle, suitable in the prep area and spray booth

Herkules Painter by Hedson secure a safe standing and ergonomic working position for the painters when working at higher vehicles.

The wheels on the lift make it easy to move around in the workshop. Due to its construction, the lift is excellent for small spaces in the prep area as well as in the spray booths.

On the platform of the lift there are several air supplies as well as storage space for the tools, therefore they are always within reach.

- Smooth lifting and lowering
- Excellent for small spaces
- Safe working position
- Smart tool storage on the platform



LIFTING
BODY SHOP SOLUTIONS

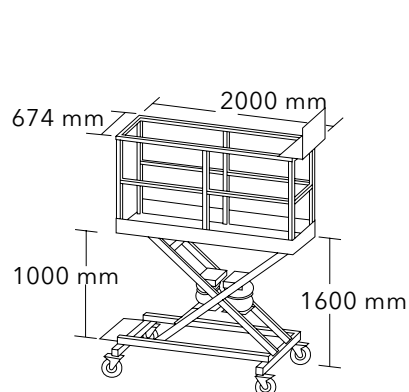

PAINTER 01

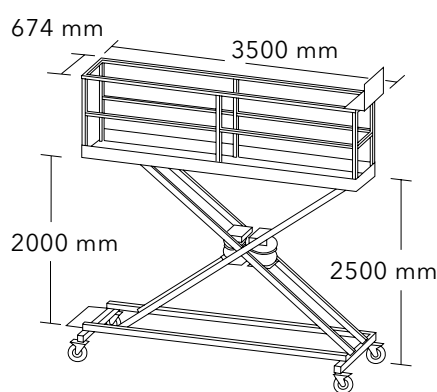

PAINTER 02/PAINTER 05

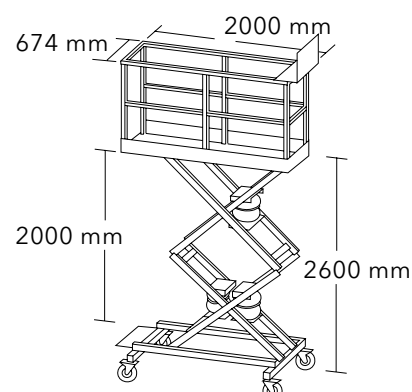

PAINTER 04

TECHNICAL DATA				
Working height	3.25 m	4.00 m	4.00 m	4.00 m
Platform dimensions	2000x674 mm	3500x674 mm	2000x674 mm	3500x674 mm
Loading capacity	150 kg	150 kg	150 kg	250 kg
Air supply	6 bar	6 bar	6 bar	6 bar
Part.no.	Painter-01	Painter-02	Painter-04	Painter-05

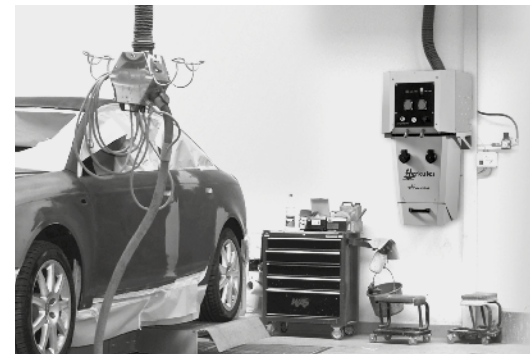

HERKULES DUST EXTRACTIONS BY HEDSON

Keep the workshop clean with reliable and high efficient vacuum system from Herkules by Hedson

The Herkules Dust Extractions by Hedson is a vacuum system for multiple users with double connection for power supply, adjustable compressed air connection and extraction. It combines recent product design, high efficiency and a user-friendly handling.

Inside the turbine there is plenty of space for tools, sanders and much more. The vacuum system solution has a swivel arm integrated, which makes it easier to reach out to several working places in the preparation area.

The turbine in the vacuum system with its 64 dB is more silent than a modern vacuum cleaner and the Hexagon energy head or alternatively the multifunctional terminal will provide work places with vacuum power, air pressure and electricity.

The dust bags are easy and safe to remove through a sliding plate and dust bag holders.

- Easy and safe removal of the dust bags
- Adjustable air pressure with manometer
- Powerful turbine but also silent, due to optimized insulation
- Wall mounted, cabinet or embedded into a wall

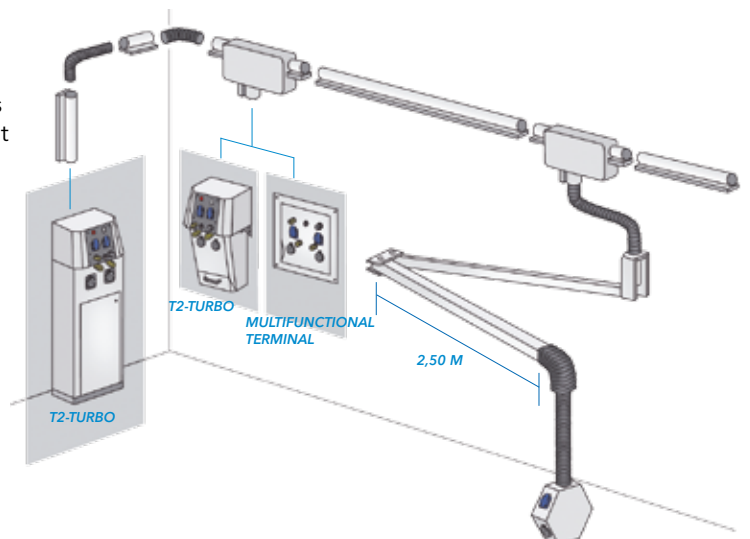

HIGH EFFICIENT AND USER FRIENDLY

A vacuum system designed for self-installation

LIFTING
BODY SHOP SOLUTIONS

The new Hexacomb combines recent product design, high efficiency and user-friendly handling.

Herkules Hexacomb Turbo has as standard equipment an automatic system start for both air and electrical tools as well as an automatic pneumatic filter cleaning. This vacuum system solution offers Hexagons with ceiling or wall assembly as well as swivel arm with a length of 5 m. The connection is a result of a pipe system.

VERY SILENT

With a maximum of 64 dB more silent than a modern vacuum cleaner.

NEW FILTER CLEANING

Filling level indication of the filter area through LED-signal. By opening the sliding piston, the filters are cleaned automatically and the dust bag can be changed in a dust reduced way.

TECHNICAL DATA	
Motor power	1300 W
Circulatory	220 m ³ /h
Depression	220 mbar
Filter area	10470 cm ²
Noise level max.	64 dB
Electric tension	230 V 50-60Hz

- ✓ Filling level indication through LED-signal
- ✓ Adjustable air pressure with manometer
- ✓ Real multiple user system: double connection for power supply, compressed air and extraction
- ✓ Powerful turbine
- ✓ Silent turbine due to optimized insulation
- ✓ Ergonomic and dust-reduced dust disposal through a sliding plate and dust bag holders



Safety guidance of the swivel arms through a smooth-running gear ring connection.



Ergonomic and dust-reduced dust disposal through a sliding plate and dust bag holders.



Dust-reduced disposal by opening the sliding plate. The dust goes into the dust bag.



MULTIFUNCTIONAL TERMINAL		
Terminal for flush-mounting, max. 2 operators		
Electric tension	2x240 V	2x240 V 1x400 V
Part.no.	C1C-240	C1C-400

AVAILABLE HOSES	
Part.no.	Description
F1A	Vacuum hose 5 m
F1B	Vacuum hose 7 m
F1C	Vacuum hose 9 m
F1D	Vacuum hose with air line 5 m
F1E	Vacuum hose with air line 7 m
F1F	Vacuum hose with air line 9 m
F2D	Vacuum hose with electrical line 5 m
F2E	Vacuum hose with electrical line 7 m
F2F	Vacuum hose with electrical line 9 m
F3D	Vacuum hose with air line 5 m 360°
F3E	Vacuum hose with air line 7 m 360°
F3F	Vacuum hose with air line 9 m 360°
F1D-E	Vacuum hose with airline and grounding, 5 m
F1E-E	Vacuum hose with airline and grounding, 7 m
F1F-E	Vacuum hose with airline and grounding, 9 m

T2 TURBO, WALL-MOUNTED	
Electric tension	1,3 kW
Part.no.	E1W

HEXACOMB T2, WALL-MOUNTED	
Swivel arm 5 m Hexagon energy head Holder for hoses and tools	
Electric tension	1,3 kW / 230 V
Part.no.	HEXA-COMB-T2W

T2 TURBO, CABINET	
Electric tension	1,3 kW
Part.no.	E1S

HEXACOMB T2, CABINET	
Swivel arm 5 m Hexagon energy head Holder for hoses and tools	
Electric tension	1,3 kW / 230 V
Part.no.	HEXA-COMB-T2S

CONSUMABLES	
Part.no.	Description
200-236	Panel E1S for flush-mounting
D1G	Set of pipe connection 5 M between T2 turbine and C1C terminal for exhaust, compressed air and electricity
300-408	Magnetic support
C1A	Hexagon with T-piece
C1B	Swivel arm 5 m and Hexagon
C1E	Main distribution line (per m)
D1A	T-piece for main distribution line
340-007	Festo adapter IAS 2
300-404	Festo adapter IAS 3

FLEXIBLE UNIT FOR THE VACUUM SYSTEM

The mobile working place in the prep area

Very flexible unit for the vacuum system. The compact unit offers a huge storage surface and suspensions for tools and consumables. With the big rollers, the Herkules T-2 Mobile by Hedson is moveable on grids and everywhere else in the workshop. All required tools are immediately available.

- Strong vacuum power
- Long life time
- Automatic filter cleaning
- Dust-reduced disposal

TECHNICAL DATA	
Turbine unit	1.3 kW / 230 V
Air volume	220 m³/h
Filter class	dust class M
Filter surface	approx. 10 470 cm²
Part.no.	T2M



LIFTING BODY SHOP SOLUTIONS

The powerful station supplies two working places with exhaust and energy.



The magnetic equipment holder can be freely positioned to all metal areas.



Very easy and almost dustless you can replace the dust from an ordinary bag.



INCREASE THE PRODUCTIVITY

Organize the work in the workshop for a safer and more efficient work process

Herkules by Hedson offers equipment that facilitates and improves the efficiency in the workshop.

HERKULES LACKY TENDER

Organize the prepared parts like doors, spoiler and wings in a safe way with the Herkules Lacky Tender by Hedson - the perfect carrying and storage system in the workshop.

The carriage has two stabilized basements in the lower area, a flexible grating ground and two small mountable boxes on the sides. The carriage also provides additional capacity for working tools and consumables.

- Cushioned rack for bulks
- Safety fixation with tension belt
- Continuous extractable bearings
- Easy to move around in the workshop



TECHNICAL DATA	
Length	900 mm
Width	680 mm
Height	2020 mm
Weight	45 kg
Part.no.	300-297

HERKULES LACKY BUMPER

Herkules Lacky Bumper by Hedson is a perfect solution for safe storage and easy transportation of bulky vehicle parts.

- Adjustable in many ways
- Padded shelves
- Easy to rank

TECHNICAL DATA	
Length	1200 mm
Width	800 mm
Height	2000 mm
Weight	28 kg
Part.no.	300-399



HERKULES LACKY TABLE

Save time and effort with the Herkules Lacky table by Hedson. The table has a lot of storage space for painting materials and tools. The lowered working surface prevents solvent overflow and has an outflow tunnel for pouring into a collecting tank. A paper roll holder is available as an accessory. Thanks to the defined extraction at the bottom of the working surface, reliable extraction is possible.

- Stainless steel
- Lowered working surface
- Outflow tunnel
- Optimum solvent extraction



LIFTING
BODY SHOP SOLUTIONS

TECHNICAL DATA		
Width	1200 mm	1800 mm
Overall height	1395 mm	1395 mm
Depth	650 mm	650 mm
Part.no.	LT-05	LT-06
<i>Paper roll holder and extraction system available as accessories.</i>		

OPTIONS	
Part.no.	Description
820-328	Extraction for LT-05
820-328-1	Extraction for LT-06
LST-02	Paper roll stand
LST-01	Paint gun stand

HERKULES STEP-BENCH

This aluminium step-bench is perfect when painting the roofs of large vehicles such as vans and small trucks. It is easy to put away when not in use - It doesn't require a lot of space.

- Space-saving
- Light

TECHNICAL DATA	
Loading capacity	120 kg
Weight	5,0 / 6,5 kg
Dimensions	1000x330x325 mm 1190x330x600 mm
Part.no.	300-257



HERKULES PAINT STAND

The Herkules Paint stand by Hedson is a quick and safe painting- and assembly stand for the workshop.

- Wide range of adjustments
- Robust but easy to handle
- Extendable

Part.no. BL-01





THE EFFICIENT TIRE SHOP

Technology that improves the speed, efficiency and profitability

Hedson has a long and successful history of continuous research and improvement of lifts and wheel washers, ensuring a high quality of developed products. With the focus on customer satisfaction and retention, Hedson provides efficient and effective solutions for all professional shops handling tires.

INCREASE THE SERVICE LEVEL - EARN MORE MONEY

Washing wheels with a Drester by Hedson wheel washer is a profitable service that improves wheel balancing results and adds real customer value.

The Drester by Hedson wheel washer cleans the wheels more carefully, more efficiently and more effectively than any other wheel washer on the market. It takes about 30 seconds to wash a dirty steel rim, aluminium rims may require the washing cycle to be increased. With the fully automatic wheel washer the productivity in the workshop increases and reduces the demand for labours.

With a Herkules by Hedson lift it is easy to change wheels in the tire shop. Adjusting of the working height, is done safely and smoothly and the workers can work in a correct position. Due to its compact construction, the lift also fit in all types of shops.

ENVIRONMENTALLY FRIENDLY

The environmentally friendly Drester by Hedson cleaning method cleans all kinds of wheels and rims in a highly efficient yet gentle way with plastic granules and heated water. The water consumption per washed wheel is very low and no chemicals that can be harmful for the rims, the user or the environment are being used. All wheel washers work with a closed water system. This means that the machine can be placed anywhere in the shop and water connection is not needed. The closed water system also combines efficient water purification and waste handling and it's easy to change water in the wheel washers. Water and dirt particles are separated by sedimentation, the water is let out, and the remaining dirt sediments are removed manually or with a sludge sucker.

- Ergonomic and easy to use solutions that improve the work flow
- Reduced energy consumption
- Environmentally friendly technology
- Outstanding cleaning performance that saves time and money



DRESTER GRAND PRIX WHEEL WASHERS

Superior wheel washers with an unmatched cleaning results in the shortest time

The Drester Grand Prix by Hedson series set the standard for wheel washers, with an outstanding cleaning performance for all kinds of rims. The fastest and most efficient cleaning method combined with an attractive design and easy to use software. After the use of the Drester water cleaning system, the waste water fulfils all the authority limit values and requirements.

Washing wheels is a profitable service that improves wheel balancing results and adds real customer value. The environmentally friendly Drester cleaning method washes all kinds of wheels and rims in a highly efficient yet gentle way.

MARKET LEADER

Ever since Drester developed the plastic granule cleaning technology and built the first original Drester wheel washers in 1989, Drester has been in a market leading position in terms of cleaning efficiency, technical developments, ergonomic and user friendly machines and environmentally friendly aspects. Thousands and thousands of shop owners

have experienced the advantages with a Drester wheel washer, such as easier handling of the wheels, improved productivity and satisfied customers. *Don't work harder - work faster!*

CLOSED WATER SYSTEM

The Drester GP wheel washers use a closed water system - the machines are operated without water or sewage connections - requiring only electricity and compressed air. The system uses water very efficiently, consuming just one litre per wheel. If required, the Drester waste water cleaning method can be used. By using a flocculation agent and a mixing motor, water and residuals are separated. The filtered clean water can be let out into the drain.

- Highly efficient cleaning method
- Sophisticated and easy to use software
- Low water consumption
- Ergonomic handling of wheels

IMPROVE THE PROFITABILITY

The Drester Grand Prix 24 Le Mans by Hedson increases productivity and profitability in the workshop

The latest member to the Grand Prix series of wheel washers is Drester GP24 Le Mans by Hedson, an advanced and fully automatic wheel washer.

The fully automatic cleaning process increases the productivity in the workshop and reduces the demand for an operator. The machine works automatically and without interruption until the last wheel is cleaned. Load the wheels on a trolley, dock it to the machine and push the start button - the machine will take care of the rest. With the trolleys there is no need for extra lifts.

The Drester GP24 by Hedson washes all kinds of alloy and SUV wheels with the dynamic flush pipe technology. The dynamic flush pipe sweeps along the outside of the rim during the cleaning, this makes the target area of the granules more efficient than that of a fixed nozzle.

- Short payback time - approx. 14 months*
- Reduces manpower by approx. 500 working hours**
- Improves workflow and ergonomics in the workshop
- Environmentally friendly cleaning method and waste handling



TECHNICAL DATA	
Wheel width	135-350 mm (5"-14")
Wheel diameter	540-800 mm (22"-31")
Max Wheel Weight	45 kg (99 lbs)
Compressed air connection	8-12 bar (120-174 psi)
Air consumption	400 litre/wash cycle
Air flow	1000 litre/min. at 7 bar
Power supply	400V, 3~, 50 Hz, 16 A
Measures (WxDxH) Height, open lid	1620 x 1100 x 1550 mm (64"x 43" x 61") 2360mm (93")
Weight of unit	320 kg (704 lbs) without water or DoublePower
Weight of trolley	56 kg/trolley
Water volume	300 liter (79 US-gallon)
Water consumption	1 litre/washed wheel
Cleaning time/ wheel***	adjustable settings from 25-155 sec settings when delivered 25, 50, 75, 100 sec
Clean rinse	0.3 litre/wheel
Included in delivery	2 trolleys, 20 kg (44lbs) of DoublePower Granules, Heater, Granule Basket, Clean Rinse, Granule Filter
Part.no. (standard unit)	GP241-AK

(For extra features - please contact your local distributor)

CONSUMABLES	
Part.no.	Description
230794	DoublePower Granules (20 kg, 44 lbs)
R12038	Hose Filter (Water Cleaning)
R12037	Basket Filter (Water Cleaning)
R12076	Flocculation Powder (Water Cleaning)
BIO-291	Detergent BIO-291

OPTIONS & ACCESSORIES	
Part.no.	Description
230350	Water Cleaning
230556	Trolley/Docking Unit
230508	Granule Filter

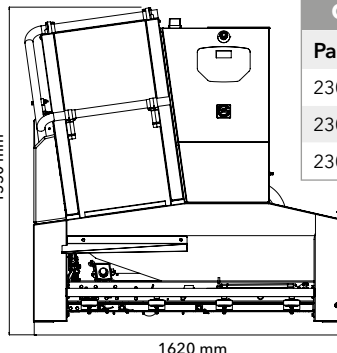

* Payback time when washing 8000 wheels/year. € 2,5, - charged cleaning cost /wheel.

** Saves at least one personnel during three months of high season.

*** Dry blowing not included



ENVIRONMENTALLY FRIENDLY CLEANING

Efficient and environmentally friendly cleaning method with plastic granules and heated water

The Drester GP12 and GP10 by Hedson provides an outstanding cleaning result for all kinds of rims, the fastest and most rational cleaning combined with an attractive design and sophisticated but easy to use software.

Get both clean wheels and a clean conscience with GP wheel washers from Drester by Hedson. The water consumption per washed wheel is very low and no chemicals that can be harmful for the user or the environment are being used. The plastic granules (Drester DoublePower by Hedson) are made of disposable material.

With the innovative and pioneering Drester Quick Lift by Hedson (patent pending), together with the door loading system of the Drester Grand Prix by Hedson wheel washers, Hedson takes a major leap forward in ergonomic wheel handling. The Quick Lift loads a heavy wheel in less than 3 seconds, and it can easily be adapted to below models from Drester Grand Prix series.

- Energy-saving intelligent heating system
- Low water consumption through closed water system
- Environmentally friendly and gentle cleaning method
- Programmable wash cycles, time controlled heater
- Heat insulating and impact resistant HPE water tank

OPTIONS & ACCESSORIES		CONSUMABLES	
Part.no.	Description	Part.no.	Description
230357	Clean Rinse	230794	DoublePower Granules (20 kg, 44 lbs)
230350	Water Cleaning	R12038	Hose Filter (Water Cleaning)
230315	Quick Lift	R12037	Basket Filter (Water Cleaning)
230508	Granule Filter	R12076	Flocculation Powder (Water Cleaning)
		BIO-291	Detergent BIO-291

* Dry blowing not included

TECHNICAL DATA	
Wheel width	145-360 mm (6"-15")
Wheel diameter	540-860 mm (22"-34")
Max Wheel Weight	60 kg (132 lbs)
Compressed air connection	8-12 bar (120-174 psi)
Air consumption	400 litre/wash cycle
Air flow	1000 litre/min. at 7 bar
Power supply	400V, 3~, 50 Hz, 16 A
Measures (WxDxH)	1090 x 1250 x 1500 mm (42x49x59")
Weight of unit	Without water or DoublePower
GP 12	240 kg (530 lbs)
GP 10	230 kg (510 lbs)
Weight of Quicklift	26 kg (60 lbs)
Water volume	310 litre (82 US-gallon)
Water consumption	1 litre/washed wheel
Cleaning time/wheel*	Adjustable settings from 25-155 sec
	Settings when delivered:
GP12	25, 50, 75, 100 sec
GP10	30, 60, 90, 120 sec
Clean rinse	0.3 litre/wheel
Included in delivery	1 rubber mat, 20 kg (44 lbs) of DoublePower Granules, Heater, Granule Basket
Part.no. (standard unit)	
GP12	WD12304-AD1
GP10	WD10302-AD1
<i>(For extra features - please contact your local distributor)</i>	

DRESTER GP 12 SILVERSTONE

Premium wheel washer with outstanding cleaning performance

The GP 12 has a patented dynamic flush pipe for fast and efficient cleaning, especially good for cleaning high polished alloy rims, big tires (SUV, transporters), and more sophisticated rims.

- Short payback time - approx. 13 months*
- Dynamic flush pipe for fast and efficient cleaning



Drester GP 12 Silverstone - with Quick Lift

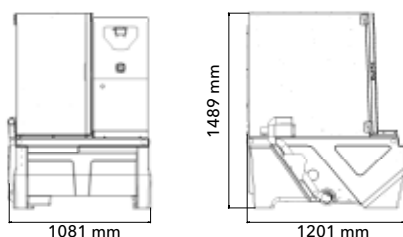

Drester GP 12 Silverstone - without Quick Lift (standard unit)

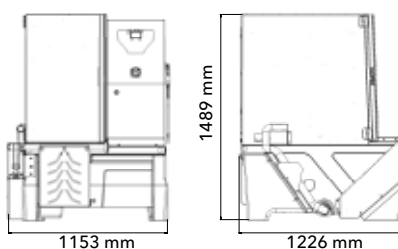

Drester GP 12 Silverstone - with Quick Lift

DRESTER GP 10 MONZA

Rational and efficient wheel washer with fantastic cleaning performance

The GP 10 wheel washer has fixed flush pipes for rational and efficient cleaning, suitable for standard tires.

- Short payback time - approx. 10 months*
- Fixed flush pipes for rational and efficient cleaning



Drester GP 10 Monza - with Quick Lift

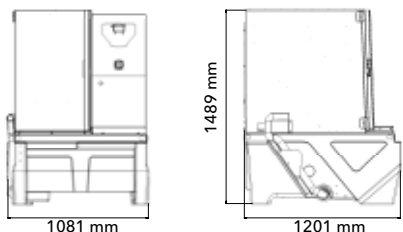

Drester GP 10 Monza - without Quick Lift (standard unit)

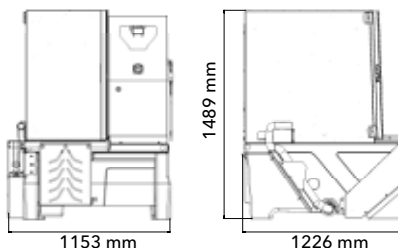

Drester GP 10 Monza - with Quick Lift

* Payback time when washing 4000 wheels/year. € 2,5, - charged cleaning cost /wheel

EFFICIENT CLEANING FOR ALL KINDS OF WHEEL

Compact and powerful wheel washer for every workshop

Drester W-450 PowerWash by Hedson is a compact and easy to use wheel washer suitable for every workshop where tires are handled. The advanced fixed nozzle geometry enables a very efficient cleaning of all kinds of wheels.

The space saving wheel washer works with a closed water system. This means that the machine can be placed anywhere in the shop. No need for a water connection and a drain next to the machine and the water consumption per washed wheel is very low, 1 litre/wheel.

If required, the Drester water cleaning method can be used. By using a flocculation agent and a mixing motor, water and residuals are separated. The filtered clean water can be let out into the drain.

- Short payback time - approx. 16 months*
- Improves workflow and ergonomics in the workshop
- TPMS friendly cleaning method
- Compact and space saving design



CLEANING
TIRE SHOP SOLUTIONS

TECHNICAL DATA	
Wheel width	135-305 mm (5-12")
Wheel diameter	560-800 mm (22-31")
Max Wheel Weight	45 kg (99 lbs)
Compressed air connection	8-12 bar (120-174 psi)
Air consumption	400 litre/wash cycle
Air flow	1000 litre/min. at 7 bar
Power supply	400V, 3~, 50 Hz, 16 A 230V, 3~, 50 or 60 Hz, 32 A
Measures (WxDxH)	1140 x 1005 x 1450 mm (45x39.5x57")
Weight of unit	220 kg (704 lbs) without water or DoublePower
Water volume	210 litre (55.5 US-gallon)
Water consumption	1 litre/washed wheel
Cleaning time/ wheel**	30, 60, 90, 120 sec
Clean rinse	1 litre/wheel
Included in delivery	1 rubber mat, 20 kg (44 lbs) of DoublePower Granules, Heater, Granule Basket
Partno. (standard unit)	W-450-1AD

(For extra features - please contact your local distributor)

OPTIONS & ACCESSORIES	
Part.no.	Description
14830	Clean Rinse
230812	Water Cleaning
230508	Granule Filter

CONSUMABLES	
Part.no.	Description
230794	DoublePower Granules (20 kg, 44 lbs)
R12038	Hose Filter (Water Cleaning)
R12037	Basket Filter (Water Cleaning)
R12076	Flocculation Powder (Water Cleaning)
BIO-291	Detergent BIO-291

Drester W-450 with open lid

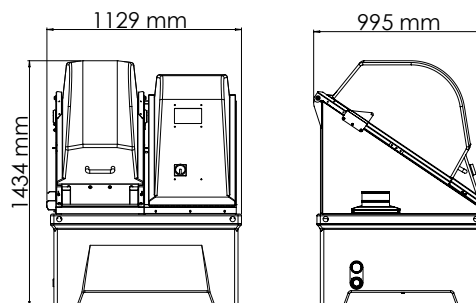

* Payback time when washing 2000 wheels/year. € 2,5, - charged cleaning cost/wheel
 ** Dry blowing not included

EFFICIENT CLEANING PROCESS

Optimal cleaning performance with Drester DoublePower granules

Only water and the new Drester DoublePower granules are used to wash wheels in the Drester wheel washers by Hedson. The water and granules are flushed onto the rotating wheel with pressure.

Different granule textures are used to optimize the washing process; the characteristics of the mix of granules are crucial for an excellent cleaning performance.

The Drester cleaning method with granules is an environmentally friendly and time efficient cleaning technology. Neither detergents or chemicals are needed.

- Minimal environmental impact due to no need for chemicals
- Contributes to low water consumption in the cleaning process
- 1 package contains 20 kg (44 lbs) and is enough to fill the wheel washer for 1 filling which lasts for at least 4000 washed wheels
- The green and white DoublePower is a long lasting and very efficient cleaning agent

Part.no. 230794



SAVES MONEY AND THE ENVIRONMENT

Filter suitable for all Drester wheel washers

Drester by Hedson has developed a new device suitable for all Drester wheel washers - Drester Granule Filter by Hedson. The granule filter is a useful device that prevents the granules from ending up in the drain. Simply connect the filter on to the drain hose. The filter collects the granules which saves both money and the environment.

Part.no. 230508



DRESTER WHEEL WASHERS BY HEDSON

Standard features and equipment

CLEANING
TIRE SHOP SOLUTIONS

	GP24	GP12	GP10	W-450
Intelligent Heater	●	●	●	
Immersion Heater				●
Granule Filter	●			
Granule Basket	●	●	●	●
Rubber mat		●	●	●
Clean Rinse	●			
Phase recognition	●	●	●	
Auto Start		●	●	
Adjustable washing programs	●	●	●	
Trolleys/Docking Unit	●			
Double Power Granules (20 kg, 44 lbs)	●	●	●	●
Prepared for water cleaning	●	●	●	●



PERFORMANCE ABOVE ALL

Hedson is a leading supplier of premium curing, lifting and cleaning systems for auto workshops and industry worldwide. We come from the land of engineering, and have decades of experience learning from and innovating to real customer needs – technologies that improve the working environment, protect workers and boost productivity. Our ambition to add real measurable values is obvious wherever Hedson solutions are seen, sold or working – from advanced yet easy to use equipment to unmatched customer service, Hedson stands for performance above all.

Ask for Hedson at your local distributor, or visit us at www.hedson.com

